

Interchangeable Lens
Digital Camera

α99 II

A-mount

Instruction Manual



“Help Guide” (Web manual)

Refer to “Help Guide” for in-depth instructions on the many functions of the camera.

http://rd1.sony.net/help/ilc/1630/h_zz/

Check out the Help Guide!



The “Help Guide” is an on-line manual that you can read on your computer or smartphone. Refer to it for details on menu items, advanced usage, and the latest information on the camera.



Scan here

http://rd1.sony.net/help/ilc/1630/h_zz/

ILCA-99M2 Help Guide



Instruction Manual (this book)



This manual introduces some basic functions.

For the quick start guide, see “Startup guide” (page 28). The “Startup guide” introduces the initial procedures from when you open the package until you release the shutter for the first shot.

In-Camera Guide



The [In-Camera Guide] shows explanations of the menu items on the monitor of the camera.

You can quickly pull up information during shooting. To use the [In-Camera Guide] function, some settings must be made beforehand. For details, search “In-Camera Guide” in the Help Guide.

Owner's Record

Record the model and serial number (which are located on the product) in the space provided below. Refer to these numbers whenever you call your Sony dealer regarding this product.

Model No. ILCA-

Serial No. _____

WARNING

To reduce fire or shock hazard, do not expose the unit to rain or moisture.

IMPORTANT SAFETY INSTRUCTIONS -SAVE THESE INSTRUCTIONS DANGER TO REDUCE THE RISK OF FIRE OR ELECTRIC SHOCK, CAREFULLY FOLLOW THESE INSTRUCTIONS

If the shape of the plug does not fit the power outlet, use an attachment plug adaptor of the proper configuration for the power outlet.

CAUTION

Battery pack

If the battery pack is mishandled, the battery pack can burst, cause a fire or even chemical burns. Observe the following cautions.

- Do not disassemble.
- Do not crush and do not expose the battery pack to any shock or force such as hammering, dropping or stepping on it.
- Do not short circuit and do not allow metal objects to come into contact with the battery terminals.
- Do not expose to high temperature above 60°C (140°F) such as in direct sunlight or in a car parked in the sun.
- Do not incinerate or dispose of in fire.
- Do not handle damaged or leaking lithium ion batteries.
- Be sure to charge the battery pack using a genuine Sony battery charger or a device that can charge the battery pack.
- Keep the battery pack out of the reach of small children.
- Keep the battery pack dry.
- Replace only with the same or equivalent type recommended by Sony.
- Dispose of used battery packs promptly as described in the instructions.

Use a nearby wall outlet (wall socket) when using the supplied or recommended AC Adaptor/battery charger. If any malfunction occurs while using this product, disconnect the plug from the wall outlet (wall socket) immediately to disconnect from the power source.

If you use the product with a charge lamp, note that the product is not disconnected from the power source even when the lamp turns off.

The power cord (mains lead), if supplied, is designed specifically for use with this equipment only, and should not be used with other electrical equipment.

Power Cord

For the customers in the UK, Ireland, Malta, Cyprus and Saudi Arabia Use the power cord (A). For safety reasons, the power cord (B) is not intended for above countries/regions and shall therefore not be used there. For the customers in other EU countries/regions Use the power cord (B).

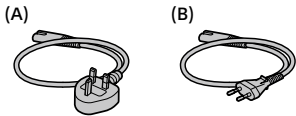

Notice

If static electricity or electromagnetism causes data transfer to discontinue midway (fail), restart the application or disconnect and connect the communication cable (USB, etc.) again.

This product has been tested and found compliant with the limits set out in the EMC regulation for using connection cables shorter than 3 meters (9.8 feet).

The electromagnetic fields at the specific frequencies may influence the picture and sound of this unit.

For Customers in the U.S.A. and Canada

RECYCLING LITHIUM-ION BATTERIES

Lithium-Ion batteries are recyclable.

You can help preserve our environment by returning your used rechargeable batteries to the collection and recycling location nearest you.



For more information regarding recycling of rechargeable batteries, call toll free 1-800-822-8837, or visit <http://www.call2recycle.org/>

Caution: Do not handle damaged or leaking Lithium-Ion batteries.

For supplied accessories

This device complies with Part 15 of the FCC Rules. Operation is subject to the following two conditions: (1) This device may not cause harmful interference, and (2) this device must accept any interference received, including interference that may cause undesired operation.

CAN ICES-3 B/NMB-3 B

This equipment complies with FCC radiation exposure limits set forth for an uncontrolled environment and meets the FCC radio frequency (RF) Exposure Guidelines. This equipment has very low levels of RF energy that is deemed to comply without testing of specific absorption rate(SAR).

The available scientific evidence does not show that any health problems are associated with using low power wireless devices. There is no proof, however, that these low power wireless devices are absolutely safe. Low power Wireless devices emit low levels of radio frequency energy (RF) in the microwave range while being used. Whereas high levels of RF can produce health effects (by heating tissue), exposure of low-level RF that does not produce heating effects causes no known adverse health effects. Many studies of low-level RF exposures have not found any biological effects. Some studies have suggested that some biological effects might occur, but such findings have not been confirmed by additional research. This equipment has been tested and found to comply with IC radiation exposure limits set forth for an uncontrolled environment and meets RSS-102 of the IC radio frequency (RF) Exposure rules.

For Customers in the U.S.A.

If you have any questions about this product, you may call:

Sony Customer Information Center
1-800-222-SONY (7669).

The number below is for the FCC related matters only.

Regulatory Information

Declaration of Conformity

Trade Name: SONY

Model No.: WW067022

Responsible Party: Sony Electronics
Inc.

Address: 16535 Via Esprillo, San
Diego, CA 92127 U.S.A.

Telephone No.: 858-942-2230

This device complies with Part15 of the FCC Rules. Operation is subject to the following two conditions: (1) This device may not cause harmful interference, and (2) this device must accept any interference received, including interference that may cause undesired operation.

This equipment must not be co-located or operated in conjunction with any other antenna or transmitter.

CAUTION

You are cautioned that any changes or modifications not expressly approved in this manual could void your authority to operate this equipment.

Note:

This equipment has been tested and found to comply with the limits for a Class B digital device, pursuant to Part 15 of the FCC Rules.

These limits are designed to provide reasonable protection against harmful interference in a residential installation. This equipment generates, uses, and can radiate radio frequency energy and, if not installed and used in accordance with the instructions, may cause harmful interference to radio communications. However, there is no guarantee that interference will not occur in a particular installation. If this equipment does cause harmful interference to radio or television reception, which can be determined by turning the equipment off and on, the user is encouraged to try to correct the interference by one or more of the following measures:

- Reorient or relocate the receiving antenna.
- Increase the separation between the equipment and receiver.
- Connect the equipment into an outlet on a circuit different from that to which the receiver is connected.
- Consult the dealer or an experienced radio/TV technician for help.

The supplied interface cable must be used with the equipment in order to comply with the limits for a digital device pursuant to Subpart B of Part 15 of FCC Rules.

For Customers in Canada

This device complies with Industry Canada's licence-exempt RSSs. Operation is subject to the following two conditions:

- (1) This device may not cause interference; and
- (2) This device must accept any interference, including interference that may cause undesired operation of the device.

For Customers in Europe**Notice for the customers in the countries applying EU Directives**

Manufacturer: Sony Corporation, 1-7-1 Konan Minato-ku Tokyo, 108-0075 Japan

For EU product compliance: Sony Belgium, bijkantoor van Sony Europe Limited, Da Vincilaan 7-D1, 1935 Zaventem, Belgium



Hereby, Sony Corporation, declares that this equipment is in compliance with the essential requirements and other relevant provisions of Directive 1999/5/EC. For details, please access the following URL:

<http://www.compliance.sony.de/>

Disposal of waste batteries and electrical and electronic equipment (applicable in the European Union and other European countries with separate collection systems)



This symbol on the product, the battery or on the packaging indicates that the product and the battery shall not

be treated as household waste. On certain batteries this symbol might be used in combination with a chemical symbol. The chemical symbols for mercury (Hg) or lead (Pb) are added if the battery contains more than 0.0005% mercury or 0.004% lead. By ensuring these products and batteries are disposed of correctly, you will help prevent potentially negative consequences for the environment and human health which could otherwise be caused by inappropriate waste handling. The recycling of the materials will help to conserve natural resources. In case of products that for safety, performance or data integrity reasons require a permanent connection with an incorporated battery, this battery should be replaced by qualified service staff only. To ensure that the battery and the electrical and electronic equipment will be treated properly, hand over these products at end-of-life to the applicable collection point for the recycling of electrical and electronic equipment. For all other batteries, please view the section on how to remove the battery from the product safely. Hand the battery over to the applicable

collection point for the recycling of waste batteries.

For more detailed information about recycling of this product or battery, please contact your local Civic Office, your household waste disposal service or the shop where you purchased the product or battery.

For Customers in Singapore

Complies with
IDA Standards
DB00353

For Customers in U.A.E.

TRA
REGISTERED No:
ER42682/15
DEALER No:
DA0073692/11

For Customers in Malaysia



For Customers in India

Battery Pack

IS 16046/IEC 62133



R-41022780



Table of contents

Check out the Help Guide!.....	2
Notes on using your camera	11

Preparations for shooting

Checking the camera and the supplied items	15
Identifying parts.....	16
Front side	16
Rear side	17
Top side	19
Sides.....	20
Bottom.....	22
Basic operations.....	23
Using the multi-selector.....	23
Using the front multi-controller	23
Using the Fn (Function) button	25
How to use the Quick Navi screen	26
Startup guide	28
Step 1: Charging the battery pack.....	28
Step 2: Inserting the battery pack into the camera	29
Step 3: Inserting a memory card.....	30
Step 4: Attaching a lens	32
Step 5: Setting the language and the clock	34
Step 6: Shooting images in auto mode.....	35

Shooting

Focusing	37
Focus Mode	37
Auto focus	39
Auto focus mechanism	39
Focus Area	41
Manual Focus	43
Direct manual focus (DMF).....	44
Continuous shooting	45
Selecting a still image size/image quality	48
 Image Size	48
 Quality	49

Shooting movies

Movie recording formats.....	50
 File Format	51
 Record Setting	53





Using wireless functions

Using the Wi-Fi/One-touch (NFC)/Bluetooth functions	56
Connecting the camera to a wireless access point	57

Using a computer

Connecting the camera to a computer	58
Connecting to a computer	58
Disconnecting the camera from the computer	59
Introduction to computer software.....	60
PlayMemories Home	60
Image Data Converter	60
Remote Camera Control.....	61

MENU items/List of icons

Using MENU items	62
List of MENU items	63
 1 (Camera Settings1).....	63
 2 (Camera Settings2)	70
 (Wireless)	75
 (Playback)	76
 (Setup).....	78
List of icons on the monitor.....	82
Indicators on the display panel.....	87

About this product

Specifications	88
Battery life and number of recordable images	88
Memory cards that can be used	89
Number of recordable images	90
Recordable movie times	92
Specifications.....	95

Index.....100

For details on the Wi-Fi functions and NFC One-touch functions, refer to the attached document “Wi-Fi Connection/One-touch (NFC) Guide” or to the “Help Guide” (page 2).

Notes on using your camera

Along with this section, also see “Precautions” in the Help Guide (page 2).

Screen language

You can select the language displayed on the screen using the menu (page 80).

Notes on recording/playback

- Once you format the memory card, all the data recorded on the memory card will be deleted and cannot be restored. Before formatting, copy the data to a computer or other device.
- Before you start recording, make a trial recording to make sure that the camera is working correctly.

Notes on handling the product

- This camera is designed to be dust and moisture-resistant, but is not waterproof or splash-proof.
- Do not leave the camera, the supplied accessories, or memory cards within the reach of infants. They may be accidentally swallowed. If this occurs, consult a doctor immediately.

No compensation for damaged content or recording failure

Sony can provide no guarantees in the event of failure to record or loss or damage of recorded images or audio data due to a malfunction of the camera or recording media, etc. We recommend backing up important data.

Notes on the monitor, electronic viewfinder, lens, and image sensor

- The monitor and electronic viewfinder are manufactured using extremely high-precision technology, and over 99.99% of the pixels are operational for effective use. However, there may be some small black dots and/or bright dots (white, red, blue or green in color) that constantly appear on the monitor and electronic viewfinder. These dots are normal due to the manufacturing process and do not affect the images in any way.
- Do not hold the camera by the monitor.
- Do not leave the lens or the viewfinder exposed to a strong light source such as sunlight. Because of the lens's condensing function, doing so may cause smoke, fire, or a malfunction inside the camera body or the lens. If you have to leave the camera exposed to a light source such as sunlight, attach the lens cap to the lens.

- When you shoot with backlighting, keep the sun sufficiently far away from the angle of view. Otherwise, the sunlight may enter the focus inside the camera and cause smoke or fire. Even if the sun is slightly away from the angle of view, it may still cause smoke or fire.
- Do not directly expose the lens to beams such as laser beams. That may damage the image sensor and cause the camera to malfunction.
- Do not look at sunlight or a strong light source through the lens when it is detached. This may result in unrecoverable damage to the eyes or cause a malfunction.
- Do not use the camera in areas where strong radio waves or radiation are being emitted. Recording and playback may not function correctly.
- Images may trail across on the screen in a cold location. This is not a malfunction.
- The recorded image may be different from the image you monitored before recording.

Notes on using lenses and accessories

It is recommended that you use Sony lenses/accessories designed to suit the characteristics of this camera. Using this camera with products from other manufacturers may affect its performance, leading to accidents or malfunction. Sony bears no responsibility for such accidents or malfunction.

Notes on the Multi Interface Shoe

- When attaching or detaching accessories such as an external flash to the Multi Interface Shoe, first turn the power to OFF. When attaching the accessory, confirm that it is firmly fastened to the camera.
- Do not use the Multi Interface Shoe with a commercially available flash that applies voltages of 250 V or more or has the opposite polarity of the camera. It may cause a malfunction.

Notes on shooting with the viewfinder

- The image may be slightly distorted near the corners of the viewfinder. This is not a malfunction. When you want to see the full composition with all its details, you can also use the monitor.
- If you pan the camera while looking into the viewfinder or move your eyes around, the image in the viewfinder may be distorted or the color of the image may change. This is a characteristic of the lens or display device and is not a malfunction. When you shoot an image, we recommend that you look at the center area of the viewfinder.

- When shooting with the viewfinder, you may experience symptoms such as eyestrain, fatigue, travel sickness, or nausea. We recommend that you take a break at regular intervals when you are shooting with the viewfinder. In case you may feel uncomfortable, refrain from using the viewfinder until your condition recovers, and consult your doctor as necessary.

Notes on continuous shooting

During continuous shooting, the monitor or viewfinder may flash between the shooting screen and a black screen. If you keep watching the screen in this situation, you may experience uncomfortable symptoms such as feeling of unwellness. If you experience uncomfortable symptoms, stop using the camera, and consult your doctor as necessary.

Notes on recording for long periods of time or recording 4K movies

- Depending on the camera and battery temperature, you may be unable to record movies or the power may turn off automatically to protect the camera. A message will be displayed on the screen before the power turns off or you can no longer record movies. In this case, leave the power off and wait until the camera and battery temperature goes down. If you turn on the power without letting the camera and battery cool enough, the power may turn off again or you may be unable to record movies.
- Under high ambient temperatures, the temperature of the camera rises quickly.
- When the temperature of the camera rises, the image quality may deteriorate. It is recommended that you wait until the temperature of the camera drops before continuing to shoot.
- The surface of the camera may get warm. This is not a malfunction.
- Especially during 4K movie shooting, the recording time may be shorter under low temperature conditions. Warm up the battery pack or replace it with a new battery.

Notes on playing back movies on other devices

Movies recorded with this camera may not be played back correctly on other devices. Also, movies recorded with other devices may not be played back correctly on this camera.

Warning on copyright

Television programs, films, videotapes, and other materials may be copyrighted. Unauthorized recording of such materials may be contrary to the provisions of the copyright laws.

On the data specifications described in this manual

The data on performance and specifications are defined under the following conditions, except as described in this manual: at an ordinary ambient temperature of 25°C (77°F), and using a battery pack that has been fully charged until the charge lamp has turned off.

How to turn off wireless network functions (Wi-Fi, NFC and Bluetooth function, etc.) temporarily

When you board an airplane, etc., you can turn off all wireless network functions temporarily.

Select MENU button →  (Wireless) → [Airplane Mode] → [On].

If you set [Airplane Mode] to [On], an  (airplane) mark will be displayed on the screen.

Notes on wireless LAN

If your camera is lost or stolen, Sony bears no responsibility for the loss or damage caused by illegal access or use of the registered access point on the camera.

Notes on security when using wireless LAN products

- Always make sure that you are using a secure wireless LAN to avoid hacking, access by malicious third parties, or other vulnerabilities.
- It is important that you set the security settings when using a wireless LAN.
- If a security problem arises because no security precautions are in place or due to any inevitable circumstances when using a wireless LAN, Sony bears no responsibility for the loss or damage.

Checking the camera and the supplied items

The number in parentheses indicates the number of pieces.

- Camera (1)
- Battery charger (1)



- Power cord (mains lead) (1)*
(supplied in some countries/
regions)



* Multiple power cords may be supplied with your camera. Use the appropriate one that matches your country/region. See page 4.

- NP-FM500H Rechargeable battery pack (1)



- Micro USB cable (1)

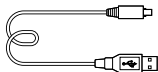

- Shoulder strap (1)

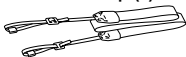

- Body cap (1) (Attached to the camera)



- Shoe cap (1) (Attached to the camera)

- Eyepiece cup (1) (Attached to the camera)

- Instruction Manual (1) (this manual)

- Wi-Fi Connection/One-touch (NFC) Guide (1)

Identifying parts

See the pages in parentheses for details.

Front side

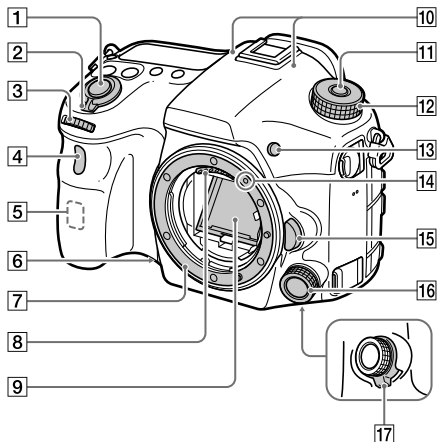

- | | |
|--|--|
| 1 Shutter button (35) | 8 Lens contacts * |
| 2 ON/OFF (Power) switch (34) | 9 Mirror* |
| 3 Front dial
You can quickly adjust the settings for each shooting mode. | 10 Microphone** |
| 4 Remote sensor/Self-timer lamp | 11 Mode dial lock release button |
| 5 Wi-Fi antenna (built-in) | 12 Mode dial (36) |
| 6 Preview button | 13 C2 button (Custom button 2) (74) |
| 7 Mount | 14 Mounting index (32) |
| | 15 Lens release button (33) |
| | 16 Front multi-controller (23) |

17 Front multi-controller click switch (23)

- * Do not directly touch these parts.
- ** Do not cover this part during movie recording. Doing so may cause noise or lower the volume.

Rear side

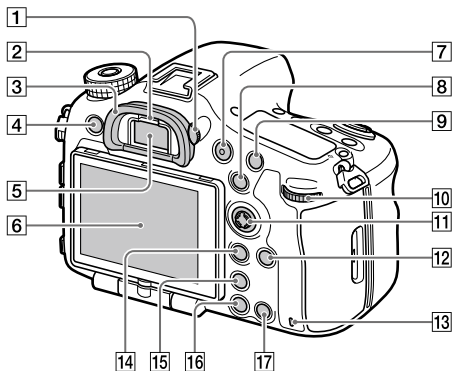

1 Diopter-adjustment dial

Adjust the diopter-adjustment dial according to your eyesight until the display appears clearly in the viewfinder. If it is hard to operate the diopter-adjustment dial, remove the eyepiece cup before operating the dial.

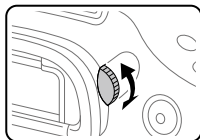

2 Eye sensor

3 Eyepiece cup

4 MENU button (62)

5 Viewfinder*

6 Monitor

You can adjust the monitor to an easily viewable angle and shoot from any position.

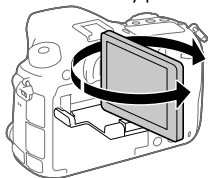

7 MOVIE (Movie) button (36)

8 For shooting: AEL button/
SLOW SYNC button
For viewing:  (Image index)
button

When shooting with a flash, shoot images while pressing and holding the SLOW SYNC button to brightly capture not only the subject but also the background.

9 For shooting: AF/MF button
For viewing:  (Enlarge)
button

10 Rear dial

You can quickly adjust the settings for each shooting mode.

11 Multi-selector/Center button
(23)

12 DISP (Display) button (73)

13 Access lamp

14 For shooting: Fn (Function)
button (25, 74)

For viewing:  (Send to
Smartphone) button

- You can display the screen for [Send to Smartphone] by pressing this button.
- When you attach a vertical grip (sold separately), pressing the  (Image rotation) button on the vertical grip displays the [Send to Smartphone] screen.

15  (Smart Telecon.) button
Smart Teleconverter magnifies and trims the center of the image, then records it.

16  (Playback) button (36)

17 For shooting: C1 button
(Custom button 1) (74)
For viewing:  (Delete) button
(36)

* Do not directly touch these parts.

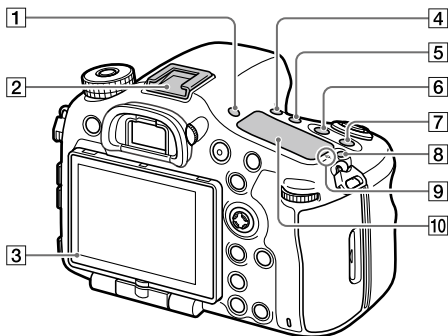

Top side



1 **FINDER/MONITOR button**
(73)

2 **Multi Interface Shoe***
Some accessories may not go in all the way and protrude backward from the Multi interface shoe. However, when the accessory reaches the front end of the shoe, the connection is completed.

3 **Light sensor**

4  /  **(Drive mode) button**
(64)

5 **WB (White balance) button**
(68)

6  **(Exposure compensation) button**
(67)

7 **ISO button** (67)

8  **(Display panel illumination) button**
(87)

9  **Image sensor position mark**

The image sensor is the sensor that converts light into an electric signal. The  mark shows the location of the image sensor. When you measure the exact distance between the camera and the subject, refer to the position of the horizontal line.

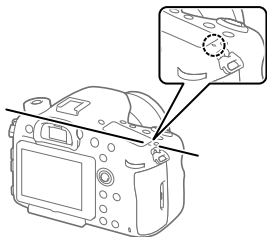

If the subject is closer than the minimum shooting distance of the lens, the focus cannot be confirmed. Make sure you put enough distance between the subject and the camera.

10 Display panel (87)

- * For details on compatible accessories for the multi interface shoe, visit the Sony website, or

consult your Sony dealer or local authorized Sony service facility. Accessories for the Accessory Shoe can also be used. Operations with other manufacturers' accessories are not guaranteed.

ni Multi
Interface Shoe

Accessory Shoe

Sides

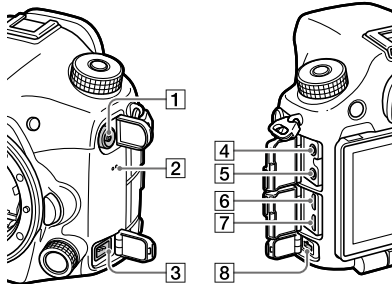

1 ⚡ (Flash sync) terminal

2 Speaker

3 REMOTE terminal

When connecting the Remote Commander (sold separately) to the camera, insert the plug of the Remote Commander into the REMOTE terminal, aligning the guide of the plug with the guide of the REMOTE terminal. Make sure that the cord of the Remote Commander faces forward.

4 🎤 Microphone jack

When an external microphone is connected, the internal microphone turns off automatically. When the external microphone is a plugin-power type, the power of the microphone is supplied by the camera.

- 5**  **Headphones jack**
You can check the sound while recording or playing back movies.
- 6** **HDMI micro jack**
- 7** **Multi/Micro USB Terminal* (58)**
This terminal supports Micro USB-compatible devices.

- 8** **DC IN terminal**
Use an AC Adaptor (sold separately) that supports shooting and playback to supply power while shooting or playing back images. When connecting the AC Adaptor (sold separately) to the camera, turn the camera off, then plug the connector of the AC Adaptor into the DC IN terminal on the camera.

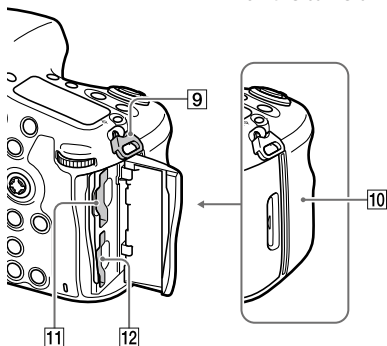

- 9** **Hooks for shoulder strap**
Attach both ends of the strap onto the camera.

- 10**  **(N mark) (56)**
This mark indicates the touch point for connecting the camera and an NFC-enabled Smartphone.

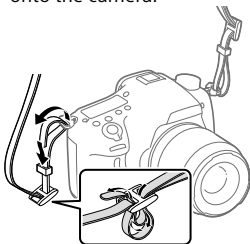

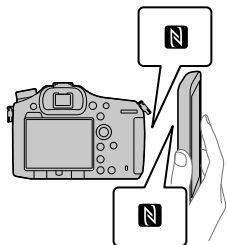

- NFC (Near Field Communication) is an international standard of short-range wireless communication technology.

**11 SLOT1 (Memory card slot 1)
(30)**

Supports SD cards and
Memory Stick PRO Duo

**12 SLOT2 (Memory card slot 2)
(32)**

Supports SD cards only

- * For details on compatible accessories for the Multi/Micro USB Terminal, visit the Sony website, or consult your Sony dealer or local authorized Sony service facility.

Bottom

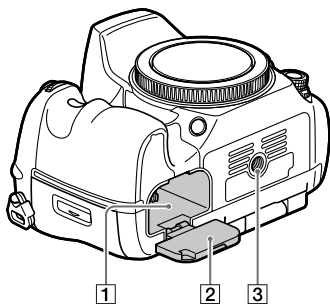

1 Battery insertion slot (29)

2 Battery cover (29)

3 Tripod socket hole

Use a tripod with a screw less than 5.5 mm (7/32 inches) long. Otherwise, you cannot firmly secure the camera, and damage to the camera may occur.

Basic operations

Using the multi-selector

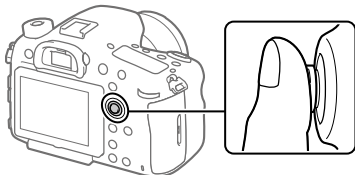

- Put your finger right on top of the multi-selector to manipulate it more precisely.
- You can move the selection frame by pressing the multi-selector up/down/left/right. The selection frame can be moved in eight directions in some situations. The item selected with the multi-selector can be entered by pressing the center of the multi-selector.
- Press the multi-selector left/right while playing back images to display the previous or next image.
- The [Focus Standard] function is assigned to the center of the multi-selector in the default settings.

Using the front multi-controller

You can change settings using the front multi-controller. The front-multi controller can be assigned different functions in the still image and movie recording modes.

- 1 Press the button on the front multi-controller during shooting to display the setting screen.**

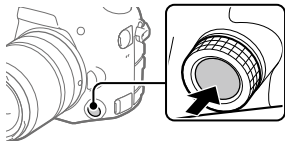



- 2 Select the desired setting by turning the front multi-controller.**

3 Press the button on the front multi-controller to enter the selection.

■ To change the assigned function

You can change the assigned function by pressing and holding the button on the front multi-controller.

The assigned function can also be changed by selecting MENU →

 2 (Camera Settings2) → [Custom Key(Shoot.)] →  Front Multi Ctrl.] or  Front Multi Ctrl.].

■ Functions that can be assigned

Focus Mode	Focus Area	Select Focus Area
Shutter Speed	Aperture	Exposure Comp.
ISO	Metering Mode	White Balance
Creative Style	Picture Effect	Audio Rec Level (only in movie mode)

Hint

- You can change the clicking pressure of the front multi-controller using the click switch. By setting the click switch to “OFF,” you can change the setting silently during movie recording.

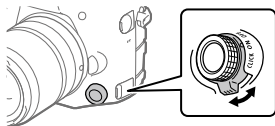

Using the Fn (Function) button

You can register frequently used functions to the Fn (function) button and recall them while shooting. Up to 12 frequently used functions can be registered to the Fn (Function) button.

- 1 When using the monitor, press the DISP button repeatedly to display a screen mode other than [For viewfinder], and then press the Fn (Function) button.**

- When using the viewfinder, this procedure is not necessary.

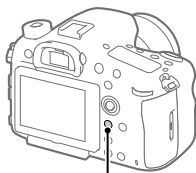

Fn button

- 2 Select a function to set by pressing the multi-selector up/down/left/right.**

- 3 Select the desired setting by turning the front dial, and press the center of the multi-selector.**

- Some functions can be fine-tuned using the rear dial.

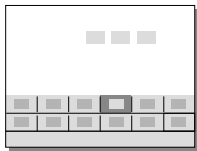

To adjust settings from the dedicated setting screens

Select the desired function in step 2, then press the center of the multi-selector. The dedicated setting screen for the function will appear. Follow the operating guide to adjust settings.

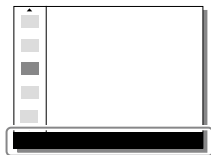

Operation guide

How to use the Quick Navi screen

The Quick Navi screen is a function optimized for shooting with the viewfinder, that lets you control settings directly.

1 Select MENU → 2 (Camera Settings2) → [DISP Button] → [Monitor] → [For viewfinder], then select [Enter].

2 Press the DISP button to set the screen mode to [For viewfinder].

3 Press the Fn button to switch to the Quick Navi screen.

- The displayed contents and their positions in the illustrations are just guidelines, and may differ from the actual displays.

Auto mode

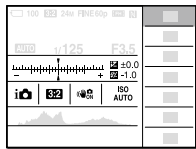
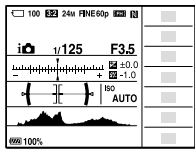

P/A/S/M/Sweep Panorama mode

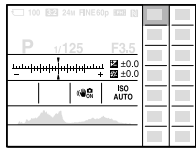
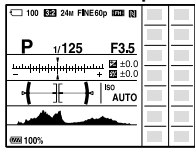

4 Select a function to set by pressing the multi-selector up/down/left/right.

5 Select the desired setting by turning the front dial.

- Some functions can be fine-tuned using the rear dial.

To adjust settings from the dedicated setting screens

Select the desired function in step 4, then press the center of the multi-selector. The dedicated setting screen for the function will appear. Follow the operating guide to adjust settings.

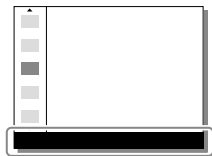

Operation guide

Note

- Items that are gray on the Quick Navi screen are not adjustable.
- When using [Creative Style], some settings can only be controlled from the dedicated screen.

Startup guide

Step 1: Charging the battery pack

- 1 Insert the battery pack into the battery charger.

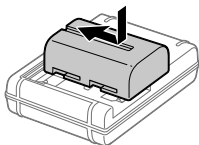

- 2 Connect the battery charger to the wall outlet (wall socket).

The CHARGE lamp on the battery charger will light up in orange and charging will start.

- How to connect the battery charger may differ depending on the country/region.

CHARGE lamp (orange)

Lit: Charging

Off: Charging finished

Flashing: Charging error or charging paused temporarily because the camera is not within the proper temperature range

With the battery charger that can be connected to the wall outlet (wall socket) directly

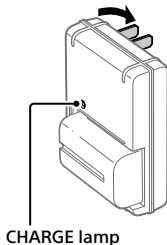

- Charging time (full charge): approximately 175 min (when charging a fully depleted battery pack at a temperature of 25°C (77°F))
- When the camera is being used for the first time or when you use a battery pack that has not been used for a long time, the CHARGE lamp may flash quickly when the battery is charged for the first time. If this happens, remove the battery pack and then re-insert it to recharge.
- Connect the battery charger to the nearest wall outlet (wall socket). If malfunctions occur while using the battery charger, disconnect the plug from the wall outlet (wall socket) immediately to disconnect from the power source. The battery charger is not disconnected from the power source even when the charge lamp turns off.

With the battery charger that requires the power cord to connect to the wall outlet (wall socket)

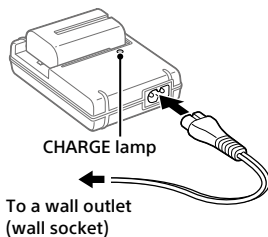

Step 2: Inserting the battery pack into the camera

1 Open the battery cover.

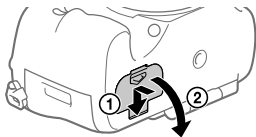

-
- 2** Insert the battery pack while pressing the lock lever with the tip of the battery until the battery locks into place.

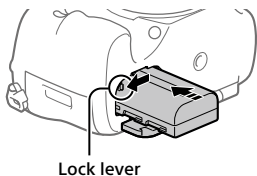

-
- 3** Close the cover.

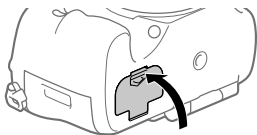

To remove the battery pack

Make sure that the access lamp (page 18) is not lit, and turn off the camera. Then, slide the lock lever and remove the battery pack. Be careful not to drop the battery pack.

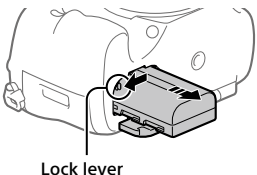

Step 3: Inserting a memory card

For details on memory cards that can be used with this camera, refer to page 89.

-
- 1** Open the memory card cover.

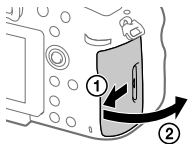

2 Insert the memory card into the slot 1.

- Ensure that the notched corner is facing in the correct direction.
- With the notched corner facing in the direction illustrated, insert the memory card until it clicks into place.
- Use the slot 1 when you are only using one memory card. The slot 1 is used in the default settings.
You can change which memory card slot to use by selecting MENU →  (Setup) → [Select Rec. Media].

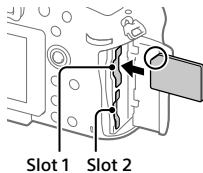

3 Close the cover.

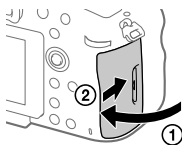

Hint

- When you use a memory card with the camera for the first time, it is recommended that you format the card on the camera for more stable performance of the memory card (page 80).

To remove the memory card

Open the memory card cover. Make sure that the access lamp (page 18) is not lit, and then push in the memory card once to remove it.

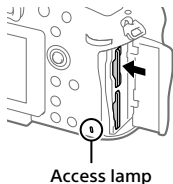

To record to memory cards in two slots

The slot 1 is used in the default settings. If you do not intend to change the settings and will only use one memory card, use the slot 1.

By inserting another memory card into the slot 2, you can record the same images to two memory cards simultaneously or record a different type of image (still images/movies) to each memory card ([Recording Mode]) (page 80).

Step 4: Attaching a lens

1 Remove the body cap from the camera and the rear lens cap from the rear of the lens.

- When changing the lens, work quickly in a dust-free environment to keep dust or debris from getting inside the camera.

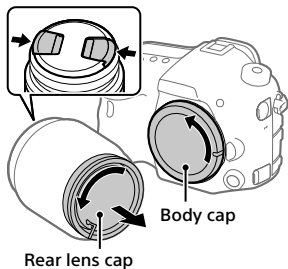

2 Mount the lens by aligning the two orange index marks (mounting indexes) on the lens and camera.

- Hold the camera with the lens facing down to prevent dust or debris from entering the camera.

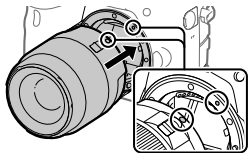

-
- 3** While pushing the lens lightly toward the camera, turn the lens slowly in the direction of the arrow until it clicks into the locked position.

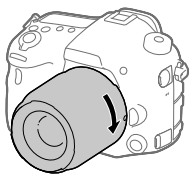
**Note**

- Be sure to hold the lens straight and do not use force when attaching a lens.
- Do not press the lens release button when attaching a lens.
- When carrying the camera with a lens attached, hold both the camera and the lens firmly.
- Do not hold the part of the lens that is extended for zoom or focus adjustment.

To remove the lens

Keep pressing the lens release button and turn the lens in the direction of the arrow until it stops.

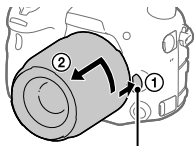

Lens release button

Step 5: Setting the language and the clock

- 1 Set the power switch to "ON" to turn on the camera.

ON/OFF (Power) switch

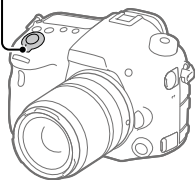

- 2 Select the desired language and then press the center of the multi-selector.



Multi-selector

- 3 Make sure that [Enter] is selected on the screen and then press the center.
- 4 Select the desired geographic location and then press the center.
- 5 Select [Date/Time] by pressing the multi-selector up/down, and then press the center.
- 6 Select the desired item by pressing the multi-selector up/down/left/right, and then press the center.
- 7 Repeat steps 5 and 6 to set other items, then select [Enter] and press the center.

Hint

- If you want to set the date and time later, you can cancel the date and time setting procedure by pressing the MENU button. In this case, the setting screen for the date and time will reappear the next time you turn on the camera.
- To reset the date and time setting, use MENU (page 80).

Note

- If the date and time setting procedure is cancelled halfway through, the setting screen for the date and time will reappear every time you turn on the camera.
- This camera does not have a function for inserting the date into images. You can insert the date into images and then save and print them using PlayMemories Home (for Windows only).

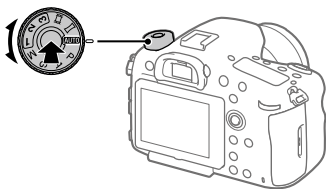
Step 6: Shooting images in auto mode**1 Press and hold the lock release button in the center of the mode dial, then turn the mode dial to set to **AUTO**.**

The shooting mode will be set to **i** (Intelligent Auto).

2 Look through the viewfinder and hold the camera.**3 Set the size of the subject by rotating the zoom ring of the lens when a zoom lens is attached.**

4 Press the shutter button halfway down to focus.

- When the image is in focus, an indicator (such as ●) will light up.
-

5 Press the shutter button all the way down.

■ To shoot movies

Press the MOVIE button to start/stop recording.

■ To play back images

Press the  (Playback) button to play back images. You can select the desired image using the multi-selector.

■ To delete displayed image

Press the  (Delete) button while an image is displayed to delete it. Select [Delete] using the multi-selector on the confirmation screen, and then press the center of the multi-selector to delete the image.

■ To shoot images in various shooting modes

Set the mode dial to the desired mode depending on the subject or the functions you want to use.

Focusing

Focus Mode

Selects the focus method to suit the movement of the subject. The focus mode switching method depends on the attached lens.

1 If the lens has a focus mode switch, set it to "AF" or "MF."

- With an SSM lens or an SAM lens that supports DMF (Direct Manual Focus)*, you can switch the focus mode to any mode including the auto focus and manual focus modes by operating the camera, even when the focus mode switch on the lens is in the "AF" position.
* SAL18135 only (as of the day this camera was released)

2 MENU → 1 (Camera Settings1) → [Focus Mode] → desired setting.

- When you want to use the auto focus function, set the focus mode switch on the lens to "AF." If the focus mode switch on the lens is set to "MF," the focus mode will be locked to [Manual Focus].
- If the lens supports the Hybrid Phase Detection AF system, every auto focus mode will use the Hybrid Phase Detection AF system as the focus detection method in the default settings. The focus detection method can be changed by selecting MENU →  1 (Camera Settings1) → [AF System].

AF-S (Single-shot AF): The product locks the focus once focusing is complete. Use this when the subject is motionless.

AF-A (Automatic AF): [Single-shot AF] and [Continuous AF] are switched according to the movement of the subject. When the shutter button is pressed halfway down, the product locks the focus when it determines that the subject is motionless, or continues to focus when the subject is in motion. During continuous shooting, the product automatically shoots with Continuous AF from the second shot.

AF-C (Continuous AF): The product continues to focus while the shutter button is pressed and held halfway down. Use this when the subject is in motion. In [Continuous AF] mode, there is no beep when the camera focuses.

DMF (DMF): You can make fine adjustments manually after the focus is locked, letting you focus on a subject more quickly than when using the manual focus from the beginning. This is convenient in situations such as macro shooting.

MF (Manual Focus): Adjusts the focus manually. If you cannot focus on the intended subject using auto focus, use manual focus.

Focus indicator

- **(lit):** The subject is in focus and the focus is locked.
- **(flashing):** The subject is not in focus.
- ⦿ **(lit):** The subject is in focus. The focus will be adjusted continuously according to the movements of the subject.
- ⦿ **(lit):** Focusing is in progress.

Subjects on which it is difficult to focus using auto focus

- Dark and distant subjects
- Subjects with poor contrast
- Subjects seen through glass
- Fast-moving subjects
- Reflective light or shiny surfaces
- Flashing light
- Back-lit subjects
- Continuously repetitive patterns, such as the facades of buildings
- Subjects in the focusing area with different focal distances

Note

- Only [Continuous AF] and [Manual Focus] are available in the movie shooting mode.

Hint

- In [Continuous AF] mode, you can lock the focus by pressing and holding the button that has been assigned the [Focus Hold] function (page 74).

Auto focus

Auto focus mechanism

This camera is equipped with a Hybrid Phase Detection AF system simultaneously driven by a focal plane phase detection AF sensor and a dedicated phase detection AF sensor. Use lenses that support the Hybrid Phase Detection AF system for a wide area, high density, multiple points, and Hybrid Cross AF Points*¹, which are difficult to achieve with just a single dedicated phase detection AF sensor.

- For details on compatible lenses, refer to the support site.
<http://www.sony.net/hpd/>

*¹ In Hybrid Cross AF Points, the focal plane phase detection AF sensor and dedicated phase detection AF sensor work together. These points have a superior capturing ability and can achieve high-accuracy focusing.

Auto focus area in Hybrid Phase Detection AF

The Hybrid Phase Detection AF system is active when a lens that supports the Hybrid Phase Detection AF system is attached and [AF System] (page 65) is set to [Auto]. The Hybrid Phase Detection AF system allows you to use an auto focus function with a wide area, 399 focus points (maximum), and Hybrid Cross AF.

Conceptual diagram

When a lens that supports Hybrid Phase Detection AF and full-frame size is attached	When a dedicated APS-C size lens that supports Hybrid Phase Detection AF is attached
<div data-bbox="453 981 515 1108" style="display: flex; flex-direction: column; align-items: center;"> <div style="display: flex; align-items: center; margin-bottom: 5px;"> (A)</div> <div style="display: flex; align-items: center; margin-bottom: 5px;"> (B)</div> <div style="display: flex; align-items: center; margin-bottom: 5px;"> (C)</div> <div style="display: flex; align-items: center;"> (D)</div> </div>	<div data-bbox="829 981 891 1108" style="display: flex; flex-direction: column; align-items: center;"> <div style="display: flex; align-items: center; margin-bottom: 5px;"> (A)</div> <div style="display: flex; align-items: center; margin-bottom: 5px;"> (B)</div> <div style="display: flex; align-items: center; margin-bottom: 5px;"> (C)</div> <div style="display: flex; align-items: center;"> (D)</div> </div>

(A): Hybrid Cross AF Points

Focal plane phase detection AF (vertical detection) + dedicated phase detection AF (cross detection*², F2.8-sensitive)

(B): Hybrid Cross AF Points

Focal plane phase detection AF (vertical detection) + dedicated phase detection AF (cross detection*²)

(C): Hybrid Cross AF Points

Focal plane phase detection AF (vertical detection) +
dedicated phase detection AF (horizontal detection)

(D): Focal plane phase detection points (vertical detection)

*2 Cross detection focus points achieve high capturing performance by arranging horizontal detection points and vertical detection points in a cross shape in the same focusing area. The focus point at the center is also equipped with a F2.8-sensitive sensor that supports lenses with a minimum F-value of 2.8 or lower.

Auto focus area of the dedicated phase detection AF sensor

The dedicated phase detection AF sensor with 79 focus points is used for auto focusing when a lens that does not support the Hybrid Phase Detection AF system is attached, or [AF System] is set to [Ddc Phase AF Only].

- The number of focus points is limited to 61 in the movie shooting mode.

Conceptual diagram



(A): Dedicated phase detection AF sensor (cross detection, F2.8-sensitive)

(B): Dedicated phase detection AF sensor (cross detection)

(C): Dedicated phase detection AF sensor

Hint

- Set [Selectable AF Area] to [Only Cross-Type AF] to limit the auto focusing area to the Hybrid Cross AF Points when the Hybrid Phase Detection AF is active.

Note

- Only some of the 399 focus points in Hybrid Phase Detection AF are used in the following situation:
 - [Selectable AF Area] is set to [Only Cross-Type AF].
 - [Flexible Spot Points] is set to other than [All].
 - A lens that does not support Hybrid Phase Detection AF is attached.

- A dedicated APS-C size lens is attached.
- [APS-C/Super 35mm] is set to [On].
- Digital zoom (Smart Telecon.)
- In movie shooting mode
- Continuous shooting with a large aperture value

Focus Area

Selects the focusing area. Use this function when it is difficult to focus properly in the auto focus mode.

MENU →  1 (Camera Settings1) → [Focus Area] → desired setting.





 **Wide:** Focuses on a subject covering the whole range of the screen automatically. When you press the shutter button halfway down in the still image shooting mode, a green frame is displayed around the area that is in focus.

 **Zone:** Select a zone on the monitor on which to focus, and the product will automatically select a focus area.

 **Center:** Focuses automatically on a subject in the center of the image. Use together with the focus-lock function to create the composition you want.

 **Flexible Spot:** Allows you to move the focusing frame to a desired point on the screen and focus on an extremely small subject in a narrow area.

 **Expand Flexible Spot:** If the product cannot focus on a single selected point, it uses focus points around the flexible spot as a secondary priority area for focusing.

     **Lock-on AF:** When the shutter button is pressed and held halfway down, the product tracks the subject within the selected autofocus area. This setting is available only when the focus mode is set to [Continuous AF]. Point the cursor at [Lock-on AF] on the [Focus Area] setting screen, and then adjust the desired area to start tracking by pressing the multi-selector left/right. You can also move the tracking start area to the desired point by designating the area as a flexible spot or expand flexible spot.

Available focus areas

When the Hybrid Phase Detection AF system is active, the entire focus area including the focal plane phase detection AF area is available (A). When the Hybrid Phase Detection AF system is not active, dedicated phase detection AF area is available (B).

Conceptual diagram

The shaded area is the available focusing area.



(A)

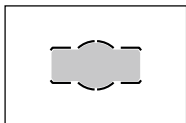

(B)

- When [Zone] is selected, the focus area is divided into 15 zones in (A), or 9 zones in (B).

To move the focus area

You can move the focus area in [Flexible Spot], [Expand Flexible Spot], or [Zone] by operating the multi-selector.

Note

- [Focus Area] is locked to [Wide] in the following situations:
 - [Intelligent Auto]
 - Lock-on AF
- The focus area may not light up during continuous shooting or when the shutter button is pressed all the way down at once.
- When the mode dial is set to  (Movie/S&Q Motion) or during movie shooting, [Lock-on AF] cannot be selected as the [Focus Area].
- When using the following zoom functions, a dotted square frame may appear around the whole screen depending on the zoom scale. The camera will perform auto focusing using the entire screen.
 - Smart zoom
 - Clear Image Zoom
 - Digital zoom

Manual Focus

When it is difficult to focus properly in the autofocus mode, you can adjust the focus manually.

1 Set the focus mode switch on the lens to "MF."

- With an SSM lens or an SAM lens that supports DMF (Direct Manual Focus)*, you can switch the focus mode to the manual focus mode by operating the camera, even when the focus mode switch on the lens is in the "AF" position.

* SAL18135 only (as of the day this camera was released)

2 If the lens does not have a focus mode switch, select MENU → 1 (Camera Settings1) → [Focus Mode] → [Manual Focus].

- If [Focus Mode] has been assigned to the front multi-controller, you can also change the setting by operating the front multi-controller (page 23).

3 Rotate the focusing ring to achieve sharp focus.

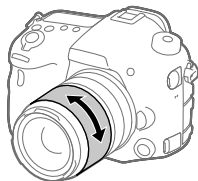

4 Press the shutter button fully down to shoot an image.

Note

- When you use the viewfinder, adjust the diopter level to obtain the correct focus on the viewfinder (page 17).

Direct manual focus (DMF)

You can make fine adjustments manually after performing auto focusing, letting you focus on a subject more quickly than when using the manual focus from the beginning. This is convenient in situations such as macro shooting.

1 MENU →  1 (Camera Settings1) → [Focus Mode] → [DMF].

2 Press the shutter button halfway down to focus automatically.

3 Keep the shutter button pressed halfway down, and then rotate the focusing ring to achieve a sharper focus.

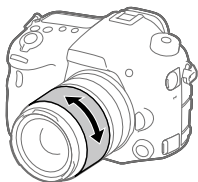

4 Press the shutter button fully down to shoot an image.

Continuous shooting



Shoots images continuously while you press and hold down the shutter button.

1 (Drive Mode) button → [Cont. Shooting].

- You can also select MENU →  1 (Camera Settings1) → [Drive Mode].

2 Select the desired mode by pressing the multi-selector right/left.

 **Continuous Shooting: Hi+**: Images are shot continuously at the maximum speed while you press and hold down the shutter button. The aperture value is locked when the first shot is taken.

 **Continuous Shooting: Hi** /  **Continuous Shooting: Mid** /  **Continuous Shooting: Lo**: Subjects are easier to track because the subject is displayed in real-time on the monitor or viewfinder during shooting.

Auto focus in continuous shooting

For the first shot of continuous shooting, all of the focus points are available if the Hybrid Phase Detection AF is active, and the dedicated phase detection AF points are available if the Hybrid Phase Detection AF is not active. Focus points available from the second shot onward are described in the table below.

Even if the lens supports the Hybrid Phase Detection AF, the auto focus area is limited to the dedicated phase detection AF area for the first shot in the following situations:

- [AF System] is set to [Ddc Phase AF Only].
- [Selectable AF Area] is set to [Only Cross-Type AF].

	Hybrid Phase Detection AF compatibility of the lens*	Auto focus capability from the second shot onward		
		Minimum F value - F3.5	F4 - F8	F9 or more
Continuous Shooting: Hi+	Compatible	All points	All points (only the focal plane phase detection AF sensor is active)	Focus is locked when the first shot is taken
	Incompatible	Dedicated phase detection AF sensor area (61 points)	Focus is locked when the first shot is taken	Focus is locked when the first shot is taken
Continuous Shooting: Hi Continuous Shooting: Mid	Compatible	All points	All points	Dedicated phase detection AF sensor area
	Incompatible	Dedicated phase detection AF sensor area	Dedicated phase detection AF sensor area	Dedicated phase detection AF sensor area
Continuous Shooting: Lo	Compatible	All points	All points	All points
	Incompatible	Dedicated phase detection AF sensor area	Dedicated phase detection AF sensor area	Dedicated phase detection AF sensor area

* For details on compatible lenses, refer to the support site.
<http://www.sony.net/hpd/>

Conceptual diagram

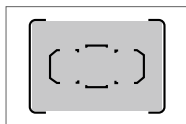

All points

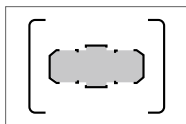

Dedicated phase detection AF sensor area

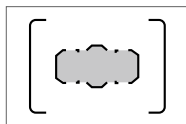

Dedicated phase detection AF sensor area (61 points)

Hint

- To continuously adjust the focus and exposure during continuous shooting, set as follows:
 - [Focus Mode]: [Continuous AF]
 -  AEL w/ shutter: [Off] or [Auto]



Note

- The shooting speed during continuous shooting becomes slower when  RAW File Type is set to [Uncompressed] in [Continuous Shooting: Hi+] mode.
- The shooting speed during continuous shooting becomes slower when [e-Front Curtain Shut.] is set to [Off] in [Continuous Shooting: Hi], [Continuous Shooting: Mid] or [Continuous Shooting: Lo] mode.
- The subject is not displayed in real-time on the monitor or viewfinder when shooting in [Continuous Shooting: Hi+] mode.
- Continuous shooting is unavailable in the following situations:
 - The shooting mode is set to [Sweep Panorama].
 - [Picture Effect] is set to [Rich-tone Mono.].
 - [DRO/Auto HDR] is set to [Auto HDR].

Selecting a still image size/image quality

Image Size

The larger the image size, the more detail will be reproduced when the image is printed on large-format paper. The smaller the image size, the more images can be recorded.

MENU →  1 (Camera Settings1) → [ Image Size] → desired setting.



When [Aspect Ratio] is set to 3:2		When [Aspect Ratio] is set to 16:9	
L: 42M	7952×5304 pixels	L: 36M	7952×4472 pixels
M: 18M	5168×3448 pixels	M: 15M	5168×2912 pixels
S: 11M	3984×2656 pixels	S: 8.9M	3984×2240 pixels

When [APS-C/Super 35mm] is set to [On]

When [Aspect Ratio] is set to 3:2		When [Aspect Ratio] is set to 16:9	
L: 18M	5168×3448 pixels	L: 15M	5168×2912 pixels
M: 11M	3984×2656 pixels	M: 8.9M	3984×2240 pixels
S: 4.5M	2592×1728 pixels	S: 3.8M	2592×1456 pixels

Note

- When [ Quality] is set to [RAW] or [RAW & JPEG], the image size for RAW images corresponds to "L."

MENU →  1 (Camera Settings1) → [ Quality] → desired setting.

RAW: File format: RAW

Digital processing is not performed on this file format. Select this format to process images on a computer for professional purposes.

- The image size is fixed to the maximum size. The image size is not displayed on the screen.

RAW & JPEG: File format: RAW + JPEG

A RAW image and a JPEG image are created at the same time. This is suitable when you need two image files, a JPEG for viewing, and a RAW for editing. The JPEG image quality is set to [Fine].

Extra fine: File format: JPEG

The image is compressed in the JPEG format and recorded using a higher quality than with [Fine].

Fine: File format: JPEG

The image is compressed in the JPEG format when recorded.

Standard: File format: JPEG

The image is compressed in the JPEG format when recorded. Since the compression rate of [Standard] is higher than that of [Fine], the file size of [Standard] is smaller than that of [Fine]. This will allow more files to be recorded on one memory card, but the image quality will be lower.

Movie recording formats

The following movie recording formats are available on this camera.

What is XAVC S?

Records movies in high definition such as 4K by converting them into MP4 movies using the MPEG-4 AVC/H.264 codec. MPEG-4 AVC/H.264 is capable of compressing images with high efficiency. You can record high-quality images while reducing the amount of data.

XAVC S/AVCHD recording formats

Format	Features
XAVC S 4K	Bit-rate: Approx. 100 Mbps or approx. 60 Mbps Records movies in 4K resolution (3840×2160).
XAVC S HD	Bit-rate: Approx. 100 Mbps, approx. 60 Mbps or approx. 50 Mbps. Records movies in crisper quality than AVCHD with larger amounts of data.
AVCHD	Bit-rate: Approx. 28 Mbps (maximum), approx. 24 Mbps (maximum) or approx. 17 Mbps (average) The AVCHD format has a high degree of compatibility with storage devices other than computers.

- Bit rate is the amount of data processed within a given period of time.

File Format

Selects the movie file format.

MENU →  **2 (Camera Settings2)** → **[File Format]** → **desired setting.**

XAVC S 4K: Records 4K movies in the XAVC S format. This format supports a high bit rate.

Audio: LPCM

- One of the following kinds of memory cards is needed to record movies with **[File Format]** set to **[XAVC S 4K]**:
 - Memory Stick PRO-HG Duo
 - Movies cannot be recorded at 100 Mbps or more.
 - SDHC/SDXC/microSDHC/microSDXC memory card (SD Speed Class 10, or UHS Speed Class U1 or faster)
 - UHS Speed Class U3 is required to record at 100 Mbps or more.
- **[HDMI Info. Display]** temporarily switches to **[Off]** when **[File Format]** is set to **[XAVC S 4K]**.
- Images will not appear on the monitor of the camera if you record movies while the camera is connected to an HDMI device with **[File Format]** set to **[XAVC S 4K]**.

XAVC S HD: Records HD movies in the XAVC S format. This format supports a high bit rate.

Audio: LPCM

- One of the following kinds of memory cards is needed to record movies with **[File Format]** set to **[XAVC S HD]**:
 - Memory Stick PRO-HG Duo
 - Movies cannot be recorded at 100 Mbps or more.
 - SDHC/SDXC/microSDHC/microSDXC memory card (SD Speed Class 10, or UHS Speed Class U1 or faster)
 - UHS Speed Class U3 is required to record at 100 Mbps or more.

AVCHD: Records HD movies in the AVCHD format. This file format is suitable for high-definition TV.

Audio: Dolby Digital

MP4: Records MP4 (AVC) movies. This format is suitable for playback on smartphones or tablets, web uploads, email attachments, etc.

Audio: AAC

Hint

- You can save images to a computer or copy them to a disc compatible with your playback device using the PlayMemories Home software.

Note

- When [File Format] is set to [AVCHD], the file size of movies is limited to approx. 2 GB. If the movie file size reaches approx. 2 GB during recording, a new movie file will be created automatically.
- When [File Format] is set to [MP4], the file size of movies is limited to approx. 4 GB. If the movie file size reaches approx. 4 GB during recording, recording will stop automatically.

Record Setting

Selects the image size, frame rate, and image quality for movie recording. The higher the bit-rate, the higher the image quality.

MENU →  2 (Camera Settings2) → [Record Setting] → desired setting.

When [File Format] is set to [XAVC S 4K]

Records high-definition movies by converting them into the MP4 file format using the MPEG-4 AVC/H.264 codec.

Frame rate	Bit-rate	
	60 Mbps	100 Mbps
30p/25p	30p 60M/25p 60M	30p 100M/25p 100M
24p	24p 60M*	24p 100M*

* Only when [NTSC/PAL Selector] is set to NTSC

When [File Format] is set to [XAVC S HD]

Records high-definition movies by converting them into the MP4 file format using the MPEG-4 AVC/H.264 codec.

Frame rate	Bit-rate		
	50 Mbps	60 Mbps	100 Mbps
120p/100p	—	120p 60M/ 100p 60M	120p 100M/ 100p 100M
60p/50p	60p 50M/ 50p 50M	—	—
30p/25p	30p 50M/ 25p 50M	—	—
24p	24p 50M*	—	—

* Only when [NTSC/PAL Selector] is set to NTSC

■ When [File Format] is set to [AVCHD]

60i/50i: Movies are recorded at approximately 60 fields/sec (for 1080 60i-compatible devices) or 50 fields/sec (for 1080 50i-compatible devices) in interlaced mode with Dolby Digital audio and in the AVCHD format.

24p/25p: Movies are recorded at approximately 24 frames/sec (for 1080 60i-compatible devices) or 25 frames/sec (for 1080 50i-compatible devices) in progressive mode with Dolby Digital audio and in the AVCHD format.

60p/50p: Movies are recorded at approximately 60 frames/sec (for 1080 60i-compatible devices) or 50 frames/sec (for 1080 50i-compatible devices) in progressive mode with Dolby Digital audio and in the AVCHD format.

Frame rate	Bit-rate		
	17 Mbps	24 Mbps	28 Mbps
60i/50i	60i 17M(FH)/ 50i 17M(FH)	60i 24M(FX)/ 50i 24M(FX)	—
60p/50p	—	—	60p 28M (PS)/ 50p 28M (PS)
24p/25p	24p 17M(FH)/ 25p 17M(FH)	24p 24M(FX)/ 25p 24M(FX)	—

■ When [File Format] is set to [MP4]

Movies are recorded in the MPEG-4 format, at approximately 60 frames/sec (for 1080 60i-compatible devices), approximately 50 frames/sec (for 1080 50i-compatible devices), approximately 30 frames/sec (for 1080 60i-compatible devices), or approximately 25 frames/sec (for 1080 50i-compatible devices), in progressive mode with AAC audio and in the MP4 format.

Frame rate	Bit-rate		
	6 Mbps	16 Mbps	28 Mbps
60p/50p	—	—	1920×1080 60p 28M/50p 28M
30p/25p	1280×720 30p 6M/25p 6M	1920×1080 30p 16M/25p 16M	—

Note

- 60p/50p movies can be played back only on compatible devices.
- Movies recorded with [60p 28M(PS)]/[50p 28M(PS)]/[60i 24M(FX)]/[50i 24M(FX)]/ [24p 24M(FX)] / [25p 24M(FX)] as the [Record Setting] are converted by PlayMemories Home in order to create an AVCHD recording disc. You cannot create a disc in the original image quality. The conversion can take a long time. If you want to keep the original image quality, store your movies on a Blu-ray Disc.
- To play back 60p/50p/24p/25p movies on a TV, the TV must be compatible with the 60p/50p/24p/25p format. If the TV is not compatible with the 60p/50p/24p/25p format, 60p/50p/24p/25p movies will be output as 60i/50i movies.
- [120p]/[100p] cannot be selected for the following settings.
 - [Intelligent Auto]

Using the Wi-Fi/One-touch (NFC)/Bluetooth functions

You can perform the following operations using the camera's Wi-Fi, NFC One-touch, and Bluetooth functions.

For details, refer to the "Help Guide" (page 2) or to the attached document "Wi-Fi Connection/One-touch (NFC) Guide."

Saving images to a computer



Transferring images from the camera to a smartphone



Using a smartphone as a remote control for the camera

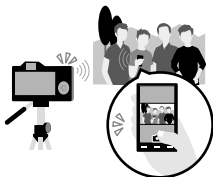

Viewing still images on a TV



Recording location information from a smartphone to images



Connecting the camera to a wireless access point

Connect the camera to your wireless access point. Before starting the procedure, make sure you have the SSID (name of the access point) and password of your wireless access point with you.

1 MENU →  (Wireless) → [Wi-Fi Settings] → [Access Point Set.].

2 Use the multi-selector to select the access point to which you want to connect. Press the center of the multi-selector and enter the password if a key icon is displayed for the wireless access point, then select [OK].

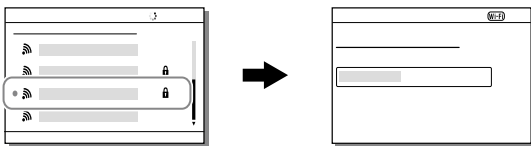

Note

- If a connection is not established, see the wireless access point operating instructions or contact the administrator of the access point. To save images to a computer, install the following dedicated software on your computer.

When using Windows: PlayMemories Home
<http://www.sony.net/pm/>

When using Mac: Wireless Auto Import
<http://www.sony.co.jp/imsoft/Mac/>

Connecting the camera to a computer

Connecting to a computer

1 Insert a fully charged battery pack into the camera, or connect the camera to a wall outlet (wall socket) using an AC adaptor (sold separately).

2 Turn on the camera and the computer.

3 Check that [USB Connection] under  (Setup) is set to [Mass Storage].

4 Connect the camera to the computer.

- When you connect the camera to the computer for the first time, the procedure for recognizing the camera may start automatically on the computer. Wait until the procedure is finished.

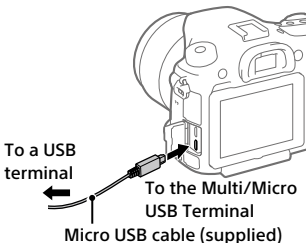

Disconnecting the camera from the computer

Perform steps 1 and 2 below before performing the following operations:

- Disconnecting the micro USB cable.
- Removing a memory card.
- Turning off the product.

1 Click  (Safely Remove Hardware and Eject Media) in the taskbar.

2 Click [Eject ILCA-99M2].

Note

- On Mac computers, drag and drop the memory card icon or the drive icon into the "Trash" icon. The camera will be disconnected from the computer.
- On Windows 7/Windows 8 computers, the disconnection icon may not appear. In that case, you can skip the steps above.
- Do not remove the micro USB cable from the camera while the access lamp is lit. The data may be damaged.

Introduction to computer software

We offer the following computer software to enhance your enjoyment of photos/movies. Access one of the following URLs using your Internet browser and then download the software by following the onscreen instructions.

If one of these programs is already installed on your computer, update it to the latest version before use.

Windows:

<http://www.sony.co.jp/imsoft/Win/>

Mac:

<http://www.sony.co.jp/imsoft/Mac/>

You can check the recommended operating environment for the software from the following URL:

<http://www.sony.net/pcenv/>

PlayMemories Home

PlayMemories Home allows you to import still images and movies to your computer and view or use them.

You need to install PlayMemories Home to import XAVC S movies or AVCHD movies to your computer.

You can access the download website directly from the following URL:

<http://www.sony.net/pm/>

- When you connect the camera to your computer, new functions may be added to PlayMemories Home. Connecting the camera to your computer is therefore recommended even if PlayMemories Home has already been installed on the computer.

Image Data Converter

You can develop and edit RAW images using various adjustment functions like tone curve and sharpness.

Remote Camera Control

With Remote Camera Control, you can change the camera settings or release the shutter from a computer connected via a USB cable. To use Remote Camera Control, first select MENU →  (Setup) → [USB Connection] → [PC Remote], then connect the camera to a computer via a USB cable.

Using MENU items

You can change settings related to all the camera operations including shooting, playback, and operating method. You can also execute camera functions from the MENU.

- 1 Press the MENU button to display the menu screen.**

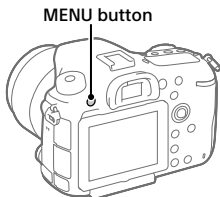

- 2 Select the setting you want to adjust by pressing the multi-selector up/down/left/right, and then press the center of the multi-selector.**

- Select an icon at the top of the screen and press the multi-selector left/right to switch to a different MENU category.











- 3 Select the desired setting value, and press the center to confirm your selection.**



List of MENU items





For details on each MENU items, refer to the reference page in the last column or the Help Guide.







1 (Camera Settings1)

Quality/Image Size		
 Quality	Sets the image quality for still images. (RAW / RAW & JPEG / Extra fine / Fine / Standard)	49
 RAW File Type	Selects the file type for RAW images. (Compressed / Uncompressed)	Help Guide
 Image Size	Selects the size of still images. (L: 42M / M: 18M / S: 11M (3:2) L: 36M / M: 15M / S: 8.9M (16:9) L: 18M / M: 11M / S: 4.5M (APS-C size, 3:2) L: 15M / M: 8.9M / S: 3.8M (APS-C size, 16:9))	48
 Aspect Ratio	Selects the aspect ratio for still images. (3:2 / 16:9)	Help Guide
APS-C/Super 35mm	Sets whether to record in APS-C-equivalent size for still images and Super 35 mm-equivalent size for movies. (On / Auto / Off)	Help Guide
Panorama: Size	Selects the size of panoramic images. (Standard / Wide)	Help Guide
Panorama: Direction	Sets the shooting direction for panoramic images. (Right / Left / Up / Down)	Help Guide
 Long Exposure NR	Sets noise reduction processing for shots with a shutter speed of 1 second or longer. (On / Off)	Help Guide

 High ISO NR	Sets noise reduction processing for high-sensitivity shooting. (Normal / Low / Off)	Help Guide
 Color Space	Changes the color space (range of reproducible colors). (sRGB / AdobeRGB)	Help Guide
Lens Comp.	Selects the type of lens compensation. (Shading Comp. / Chro. Aber. Comp. / Distortion Comp.)	Help Guide
Shoot Mode/Drive		
Drive Mode	Sets the drive mode, such as for continuous shooting. (Single Shooting / Cont. Shooting / Self-timer / Self-timer(Cont) / Cont. Bracket / Single Bracket / WB bracket / DRO Bracket)	45, Help Guide
Bracket Settings	Sets self-timer shooting in bracket mode, shooting order for exposure bracketing, and white balance bracketing. (Selftimer during Brkt / Bracket order)	Help Guide
 Recall	Calls up settings pre-registered to [Memory]. (1 / 2 / 3/ M1 - M4)	Help Guide
 Memory	Registers the desired modes and camera settings. (1 / 2 / 3/ M1 - M4)	Help Guide
AF		
Focus Mode	Selects the focus mode. (Single-shot AF / Automatic AF / Continuous AF / DMF / Manual Focus)	37
Priority Set in AF-S	Sets the timing of the shutter release when [Focus Mode] is set to [Single-shot AF], [DMF] or [Automatic AF] with a still subject. (AF / Release)	Help Guide

Priority Set in AF-C	Sets the timing of the shutter release when [Focus Mode] is set to [Continuous AF] or [Automatic AF] with a moving subject. (AF / Release / Balanced Emphasis)	Help Guide
Focus Area	Selects the area of focus. (Wide / Zone / Center / Flexible Spot / Expand Flexible Spot / Lock-on AF)	41
Selectable AF Area	Although this camera uses a maximum of 399 focus points, you can limit the number of focus points manually. (Auto / Only Cross-Type AF)	Help Guide
AF System	Sets the focus detection system to a Hybrid Phase Detection AF system that simultaneously uses a focal plane phase detection AF sensor and a dedicated phase detection AF sensor. (Auto / Ddc Phase AF Only)	Help Guide
Flexible Spot Points	Allows you to limit the usable focus points when [Focus Area] is set to [Flexible Spot] or [Expand Flexible Spot] to select the focus point quickly. (All / 63 Points / 15 Points)	Help Guide
 AF Illuminator	Sets the AF illuminator, which provides light to aid focusing in dark scenes. (Auto / Off)	Help Guide
Center Lock-on AF	Sets the function to track a subject and continue focusing when pressing the center button in the shooting screen. (Off / On)	Help Guide
 AF drive speed	Selects the focusing speed when using autofocus in the still image mode. (Fast / Slow)	Help Guide

 AF Track Sens	Sets the AF tracking sensitivity for the still image mode. (5(Responsive) / 4 / 3(Standard) / 2 / 1(Locked on))	Help Guide
 AF w/ shutter	Sets whether to perform auto focusing when the shutter button is pressed halfway down. This is useful when you want to adjust the focus and exposure separately. (On / Off)	Help Guide
 Eye-Start AF	Sets whether to use auto focus when you look through the viewfinder. (On / Off)	Help Guide
 AF Rng.Ctrl Assist	Sets whether to display the assist area on the screen when using the AF range control function. The assist area helps you check whether the subject is located within the focus range you have set. (On / Off)	Help Guide
AF Area Auto Clear	Sets whether the focus area is displayed all the time or disappears automatically shortly after focusing. (On / Off)	Help Guide
Wide AF Area Disp.	Sets whether to display the focus area when [Focus Area] is set to [Wide]. (On / Off)	Help Guide
AF Micro Adj.	Allows you to make fine adjustments to the position of the focus. (AF Adjustment Set. / Clear / AF Area: Cent W End / AF Area: Cent T End / AF Area: Up L W End / AF Area: Up L T End / AF Area: Low L W End / AF Area: Low L T End / AF Area: Up R W End / AF Area: Up R T End / AF Area: Low R W End / AF Area: Low R T End)	Help Guide









Exposure		
Exposure Comp.	Compensates for the brightness of the entire image. (-5.0EV - +5.0EV)	Help Guide
ISO	Sets the ISO sensitivity. (ISO AUTO / ISO 50 - ISO 102400)	Help Guide
ISO AUTO Min. SS	Sets the slowest shutter speed at which ISO sensitivity will start to change in [ISO AUTO] mode. (Faster / Fast / Standard / Slow / Slower / 1/8000 - 30")	Help Guide
Metering Mode	Selects the method for measuring brightness. (Multi / Center / Spot / Entire Screen Avg. / Highlight)	Help Guide
Spot Metering Point	Sets whether to coordinate the spot metering point with the focus area when [Focus Area] is set to [Flexible Spot] or [Expand Flexible Spot]. (Center / Focus Point Link)	Help Guide
Exposure step	Selects the size of the increment step for shutter speed, aperture, and exposure. (0.5EV / 0.3EV)	Help Guide
 AEL w/ shutter	Sets whether to lock the exposure when the shutter button is pressed halfway down. This is useful when you want to adjust the focus and exposure separately. (Auto / On / Off)	Help Guide
Exposure Std. Adjust	Adjusts the standard for the correct exposure value for each metering modes. ( Multi /  Center /  Spot /  Entire Screen Avg. /  Highlight)	Help Guide







Flash		
Flash Mode	Sets the flash settings. (Flash Off / Autoflash / Fill-flash / Slow Sync. / Rear Sync. / Wireless)	Help Guide
Flash Comp.	Adjusts the intensity of flash output. (-3.0EV - +3.0EV)	Help Guide
Exp.comp.set	Sets whether to reflect exposure compensation value to flash compensation. (Ambient&flash / Ambient only)	Help Guide
Flash control	Sets the method for determining the intensity of flash output. (ADI flash / Pre-flash TTL)	Help Guide
Red Eye Reduction	Reduces the red-eye phenomenon when using flash. (On / Off)	Help Guide
Color/WB/Img. Processing		
White Balance	Adjusts the color tone of images. (Auto / Daylight / Shade / Cloudy / Incandescent / Fluor.: Warm White / Fluor.: Cool White / Fluor.: Day White / Fluor.: Daylight / Flash / Underwater Auto / C.Temp./Filter / Custom1 - 3 / Custom Setup)	Help Guide
Priority Set in AWB	Selects which tone to prioritize when shooting under lighting conditions such as incandescent light with [White Balance] set to [Auto]. (Standard / Ambience / White)	Help Guide
DRO/Auto HDR	Compensates automatically for brightness and contrast. (Off / D-Range Opt. / Auto HDR)	Help Guide



Creative Style	Selects the desired image processing. You can also adjust contrast, saturation, and sharpness. (Standard / Vivid / Neutral / Clear / Deep / Light / Portrait / Landscape / Sunset / Night Scene / Autumn leaves / Black & White / Sepia / Style Box1 - 6)	Help Guide
Picture Effect	Shoots images with a texture unique to the selected effect. (Off / Toy Camera / Pop Color / Posterization / Retro Photo / Soft High-key / Partial Color / High Contrast Mono. / Rich-tone Mono.)	Help Guide
Picture Profile	Changes settings such as color and tone when recording images. (Off / PP1 - PP9) * This function is for skilled movie creators.	Help Guide
Focus Assist		
Focus Magnifier	Enlarges the image before shooting so that you can check the focus.	Help Guide
Focus Magnif. Time	Sets the length of time the image will be shown in an enlarged form. (2 Sec / 5 Sec / No Limit)	Help Guide
 Initial Focus Mag.	Sets the initial magnification scale when using [Focus Magnifier]. (x1.0 / x7.8 (Full-frame)) (x1.0 / x5.1 (APS-C size))	Help Guide
Peaking Level	Enhances the outline of in-focus areas with a specific color when focusing manually. (High / Mid / Low / Off)	Help Guide
Peaking Color	Sets the color used for the peaking function. (Red / Yellow / White)	Help Guide

Face Detection/Shoot Assist		
 Anti-flicker Shoot.	Detects flickering/blinking from artificial light sources such as fluorescent lighting and times the shooting of images to moments when flickering will have less of an impact. (Off / On)	Help Guide
Face Detection	Sets whether to detect faces and automatically adjust various settings such as focus, exposure, image processing, and flash. (Off / On (Regist. Faces) / On)	Help Guide
Face Registration	Registers or changes the person to be given priority when focusing. (New Registration / Order Exchanging / Delete / Delete All)	Help Guide











2 (Camera Settings2)

Movie		
Movie/S&Q Motion	Sets the exposure mode when shooting movies or slow-motion/quick-motion movies.  P Program Auto /  A Aperture Priority /  S Shutter Priority /  M Manual Exposure /  S&Q P Program Auto /  S&Q A Aperture Priority /  S&Q S Shutter Priority /  S&Q M Manual Exposure)	Help Guide
 File Format	Selects the movie file format. (XAVC S 4K / XAVC S HD / AVCHD / MP4)	51

 Record Setting	<p>Selects the quality and size of the recorded movie frame.</p> <p>(XAVC S 4K: 30p 100M / 25p 100M / 30p 60M / 25p 60M / 24p 100M / 24p 60M XAVC S HD: 60p 50M / 50p 50M / 30p 50M / 25p 50M / 24p 50M / 120p 100M / 100p 100M / 120p 60M / 100p 60M AVCHD: 60i 24M(FX) / 50i 24M(FX) / 60i 17M(FH) / 50i 17M(FH) / 60p 28M(PS) / 50p 28M(PS) / 24p 24M(FX) / 25p 24M(FX) / 24p 17M(FH) / 25p 17M(FH) MP4: 1920×1080 60p 28M / 1920×1080 50p 28M / 1920×1080 30p 16M / 1920×1080 25p 16M / 1280×720 30p 6M / 1280×720 25p 6M)</p>	53
 S&Q Settings	<p>Changes the settings for slow-motion and quick-motion movie shooting.</p> <p>( Record Setting /  Frame Rate)</p>	Help Guide
Dual Video REC	<p>Sets whether to simultaneously record an XAVC S movie and MP4 movie or an AVCHD movie and MP4 movie.</p> <p>(On / Off)</p>	Help Guide
 AF Track Sens	<p>Sets the AF tracking sensitivity for the movie mode.</p> <p>(Responsive / Standard / Locked on)</p>	Help Guide
 Auto Slow Shut.	<p>Sets the function that automatically adjusts the shutter speed following the brightness of the environment in movie mode.</p> <p>(On / Off)</p>	Help Guide
Audio Recording	<p>Sets whether to record audio when shooting a movie.</p> <p>(On / Off)</p>	Help Guide
Audio Rec Level	<p>Adjusts the audio recording level during movie recording.</p> <p>(0 - 31)</p>	Help Guide

Audio Level Display	Sets whether to display the audio level. (On / Off)	Help Guide
Audio Out Timing	Sets the timing of audio output during the movie recording. (Live / Lip Sync)	Help Guide
Wind Noise Reduct.	Reduces wind noise during movie recording. (On / Off)	Help Guide
 Marker Display	Sets whether to display markers on the monitor when recording movies. (On / Off)	Help Guide
 Marker Settings	Sets which markers to display on the monitor when recording movies. (Center / Aspect / Safety Zone / Guideframe)	Help Guide
Video Light Mode	Sets the illumination setting for the HVL-LBPC LED light (sold separately). (Power Link / REC Link / REC Link&STBY / Auto)	Help Guide
Shutter/SteadyShot		
e-Front Curtain Shut.	Sets whether to use the electronic front curtain shutter function. (On / Off)	Help Guide
Release w/o Lens	Sets whether to release the shutter when the lens is not attached. (Enable / Disable)	Help Guide
Release w/o Card	Sets whether to release the shutter when a memory card is not inserted. (Enable / Disable)	Help Guide
SteadyShot	Sets whether to activate SteadyShot for shooting. (On / Off)	Help Guide
SteadyShot Settings	Sets SteadyShot settings. (SteadyShot Adjust. / SteadyS. Focal Len.)	Help Guide

Zoom		
Zoom	Sets the zoom scale for zoom functions other than the optical zoom.	Help Guide
Zoom Setting	Sets whether to use the Clear Image Zoom and Digital Zoom when zooming. (Optical zoom only / On:ClearImage Zoom / On:Digital Zoom)	Help Guide
Display/Auto Review		
DISP Button	Sets the type of information to be displayed on the monitor or in the viewfinder when the DISP button is pressed. (Monitor / Finder)	Help Guide
FINDER/MONITOR	Sets the method for switching the display between the electronic viewfinder and the monitor. (Auto / Manual)	Help Guide
Zebra	Displays stripes to adjust brightness. (Off / 70 - 100 / 100+ / Custom1 / Custom2)	Help Guide
Grid Line	Displays grid lines for adjusting the image composition. (Rule of 3rds Grid / Square Grid / Diag. + Square Grid / Off)	Help Guide
Exposure Set. Guide	Sets the guide displayed when exposure settings are changed in the shooting screen. (Off / On)	Help Guide
Live View Display	Sets whether to reflect settings such as exposure compensation in screen display. (Setting Effect ON / Setting Effect OFF)	Help Guide
Auto Review	Sets auto review to display the captured image after shooting. (10 Sec / 5 Sec / 2 Sec / Off)	Help Guide

Custom Operation		
Custom Key(Shoot.)	<p>Assigns functions to the various keys so that you can perform operations more quickly by pressing the keys when shooting images.</p> <p> Front Multi Ctrl. /  Front Multi Ctrl. / Custom Button 1 / Custom Button 2 / Center Button / AEL Button / AF/MF Button /  (Smart tele-converter) button / ISO Button / Exp. Comp. Button / WB Button / Drive Mode Button / Preview Button / Focus Hold Button*)</p> <p>* You can assign a function to the focus hold button on the lens.</p>	Help Guide
Custom Key(PB)	<p>Assigns functions to the keys so that you can perform operations more quickly by pressing the keys when playing back images.</p> <p>(Custom Button 2 / Fn/ button /  (Smart tele-converter) button / ISO Button / Exp. Comp. Button / WB Button / Drive Mode Button / Preview Button)</p>	Help Guide
Function Menu Set.	Customizes the functions displayed when the Fn (Function) button is pressed.	Help Guide
Dial Setup	<p>Sets the functions of the front and rear control dials when the exposure mode is set to M. Dials can be used for adjusting shutter speed and aperture.</p> <p>( SS  F/no. /  F/no.  SS)</p>	Help Guide
Dial Ev Comp	<p>Sets whether to compensate the exposure with the front or rear dial.</p> <p>(Off /  Front dial /  Rear dial)</p>	Help Guide
MOVIE Button	<p>Enables or disables for the MOVIE button.</p> <p>(Always / Movie Mode Only)</p>	Help Guide

Dial Lock	Sets whether to disable the front and rear dials temporarily when the Fn button is pressed and held down. (Lock / Unlock)	Help Guide
Audio signals	Selects whether to sound a beep during auto focus or self-timer operations. (On / Off)	Help Guide



(Wireless)

Send to Smartphone	Transfers images to display on a smartphone. (Select on This Device / Select on Smartphone)	Help Guide
Send to Computer	Backs up images by transferring them to a computer connected to a network.	Help Guide
View on TV	Allows you to view images on a network-enabled TV.	Help Guide
Ctrl w/ Smartphone	Allows you to use a smartphone as the remote controller for the camera and shoot still images/movies. Still images/movies shot via remote control are sent to the smartphone from the camera. (Ctrl w/ Smartphone /  Connection Info.)	Help Guide
Airplane Mode	Disables wireless communications from the device such as Wi-Fi, NFC, and Bluetooth function. (On / Off)	Help Guide

Wi-Fi Settings	Allows you to register your access point and check or change the Wi-Fi connection information. (WPS Push / Access Point Set. / Disp MAC Address / SSID/PW Reset)	Help Guide
Bluetooth Settings	Controls the settings for connecting the camera with a smartphone via a Bluetooth connection. (Bluetooth Function / Pairing / Disp Device Address)	Help Guide
 Loc. Info. Link Set.	Obtains location information from the paired smartphone and records it to captured images. (Location Info. Link / Auto Time Correct. / Auto Area Adjust.)	Help Guide
Edit Device Name	Changes the device name under Wi-Fi Direct, etc.	Help Guide
Reset Network Set.	Resets all the network settings.	Help Guide





(Playback)







Delete	Deletes an image. (Multiple Img. / All in this Folder / All with this date)	Help Guide
View Mode	Plays back images from a specified date or specified folder of still images and movies. (Date View / Folder View(Still) / Folder View(MP4) / AVCHD View / XAVC S HD View / XAVC S 4K View)	Help Guide
Image Index	Displays multiple images at the same time. (9 Images / 25 Images)	Help Guide

Display Rotation	Sets the playback orientation for images shot vertically. (Auto / Manual / Off)	Help Guide
Select PB Media	Selects the memory card slot of the memory card to be played back. (Slot 1 / Slot 2)	Help Guide
Copy	Allows you to copy images from the memory card in the memory card slot designated in [Select PB Media] to the memory card in the other slot.	Help Guide
Slide Show	Plays a slide show. (Repeat / Interval)	Help Guide
Rotate	Rotates the image.	Help Guide
 Enlarge Image	Enlarges the playback images.	Help Guide
 Enlarge Init. Mag.	Sets the initial magnification scale when playing back enlarged images. (Standard. Mag. / Previous Mag.)	Help Guide
 Enlarge Initial Pos.	Sets the initial magnification area when playing back enlarged images. (Focused Position / Center)	Help Guide
Protect	Protects recorded images against accidental erasure. (Multiple Img. / All in this Folder / All with this date / Cancel All in this Folder / Cancel All with this date)	Help Guide
Specify Printing	Specifies in advance on the memory card which still images to print out later. (Multiple Img. / Cancel All / Print Setting)	Help Guide
Photo Capture	Captures a chosen scene in a movie to save as a still image.	Help Guide

 (Setup)

Monitor Brightness	Adjusts the brightness of the screen. (Auto / Manual / Sunny Weather)	Help Guide
Viewfinder Bright.	Sets the brightness of the electronic viewfinder. (Auto / Manual)	Help Guide
Finder Color Temp.	Sets the color temperature of the viewfinder.	Help Guide
Gamma Disp. Assist	Converts an S-Log image into an image with contrast equivalent to a normal gamma setting when it is displayed to assist monitoring. (Off / Auto / S-Log2 → 709(800%) / S-Log3 → 709(800%))	Help Guide
Volume Settings	Sets the volume for movie playback.	Help Guide
Upload Settings	Sets the upload function of the camera when using a commercially available Eye-Fi card. (On / Off)	Help Guide
Delete confirm.	Sets whether [Delete] or [Cancel] is preselected in the delete confirmation screen. ("Delete" first / "Cancel" first)	Help Guide
Display Quality	Sets the display quality. (High / Standard)	Help Guide
Pwr Save Start Time	Sets the time intervals to automatically switch to power save mode. (30 Min / 5 Min / 2 Min / 1 Min / 10 Sec)	Help Guide
NTSC/PAL Selector¹	Changes the TV format of the device so that you can shoot in a different movie format.	Help Guide

Cleaning Mode	Starts the cleaning mode to clean the image sensor.	Help Guide
Demo Mode	Sets demonstration playback of movies to on or off. (On / Off)	Help Guide
TC/UB Settings	Sets the time code (TC) and user bit (UB). (TC/UB Disp. Setting / TC Preset / UB Preset / TC Format / TC Run / TC Make / UB Time Rec) * This function is for skilled movie creators.	Help Guide
Remote Ctrl	Sets whether to use the infrared remote control. (On / Off)	Help Guide
HDMI Settings	Sets the HDMI settings. (HDMI Resolution /  24p/60p Output / HDMI Info. Display /  TC Output /  REC Control/CTRL FOR HDMI)	Help Guide
 4K Output Sel.	Sets how to record and output 4K movies via HDMI when the camera is connected to an external recorder/player that supports 4K. (Memory Card+HDMI / HDMI Only(30p) / HDMI Only(25p) / HDMI Only(24p))	Help Guide
USB Connection	Sets the USB connection method. (Auto / Mass Storage / MTP / PC Remote)	Help Guide
USB LUN Setting	Enhances compatibility by limiting the functions of USB connection. Set to [Multi] in normal conditions and to [Single] only when the connection between the camera and a computer or AV component cannot be established. (Multi / Single)	Help Guide

PC Remote Settings	Controls the PC remote shooting settings. (Still Img. Save Dest. / RAW+J PC Save Img)	Help Guide
 Language	Selects the language.	34
Date/Time Setup	Sets the date, time, and daylight savings.	34
Area Setting	Sets the location of use.	Help Guide
Copyright Info	Sets copyright information for still images. (Write Copyright Info / Set Photographer / Set Copyright / Disp. Copyright Info)	Help Guide
Format	Formats the memory card.	Help Guide
File Number	Sets the method used to assign file numbers. (Series / Reset)	Help Guide
Set File Name	Changes the first 3 characters of the file names for still images.	Help Guide
Select Rec. Media	Selects the memory card slot of the memory card on which to record. (Slot 1 / Slot 2)	30, Help Guide
Recording Mode	Sets the method for recording images to two memory card slots. (Standard / Simult.() / Simult.() / Simult.( / ) / Sort(JPEG/RAW) / Sort( / ))	Help Guide
Select REC Folder	Changes the folder selected for storing still images and movies (MP4).	Help Guide
New Folder	Creates a new folder for storing still images and movies (MP4).	Help Guide
Folder Name	Sets the folder format for still images. (Standard Form / Date Form)	Help Guide
Recover Image DB	Recovers the image database file and enables recording and playback.	Help Guide

Display Media Info.	Displays the remaining recording time of movies and the recordable number of still images on the memory card.	Help Guide
Version	Displays the camera software version.	Help Guide
Certification Logo^{*2}	Displays certification information for the camera (only some of the certification logos are displayed).	Help Guide
Setting Reset	Restores settings to their defaults. Select [Initialize] to restore all settings to their default values. (Camera Settings Reset / Initialize)	Help Guide

*1 If you change this item, you will need to format the memory card for compatibility with the PAL or NTSC system. Also, note that it may not be possible to play back movies recorded for the NTSC system on PAL system TVs.

*2 Overseas models only.

List of icons on the monitor

The displayed contents and their positions in the illustrations are just guidelines, and may differ from the actual displays.

Monitor mode

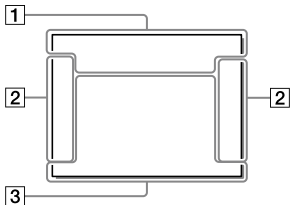

For playback

Basic information display

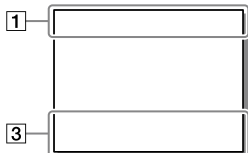

Viewfinder mode

[Intelligent Auto] mode

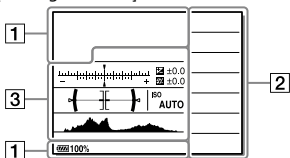

Histogram display

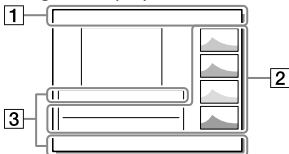

P/A/S/M/Sweep Panorama mode

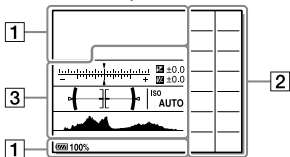

1

Display	Indication
	Shooting mode (35)
	Register number (64)
	Scene Recognition icons
	Memory card (30,89) / Upload (78)
100	Remaining number of recordable images (90)
3:2 16:9	Aspect ratio of still images (63)
42M 36M 18M 15M 11M 8.9M 4.5M 3.8M WIDE STD	Image size of still images (48)
RAW RAW+J RAW RAW+J X.FINE FINE STD	Image quality of still images (49)











Display	Indication
120p 60p 60i 30p 24p 100p 50p 50i 25p	Frame rate of movies (53)
	Record setting of movies (53)
	Bluetooth connection available / Bluetooth connection unavailable (76)
	Connected to smartphone / Not connected to smartphone
100%	Remaining battery (28)
	Remaining battery warning
	Flash charge in progress
	APS-C/Super 35mm (63)
VIEW	Setting Effect OFF(73)
	NFC active (56)
	Airplane Mode (75)
Flicker	Flickering detected (70)
OFF	No audio recording of movies (71)
	Wind Noise Reduct. (72)

Display	Indication
	SteadyShot off/ on, Camera shake warning (72)
	SteadyS. Focal Len./ Camera shake warning (72)
	Obtaining location information/ Location information cannot be obtained (76)
	Overheating warning
	Database file full/ Database file error
	Smart Zoom / Clear Image Zoom / Digital Zoom (73)
	View Mode (76)
100-0003	Folder number – File number (80)
	Protect (77)
XAVC S 4K XAVC S HD AVCHD MP4	File format of movies (51)
DPOF	DPOF set (77)
	Dual Video REC (71)

Display	Indication
—PC—	PC remote (79)
	Bright Monitoring
	Copyright information writing on (80)
Assist 1 Assist 1 L 5-Log2 L 5-Log3	Gamma Disp. Assist (78)
120fps 60fps 30fps 15fps 8fps 4fps 100fps 50fps 25fps 12fps 6fps 3fps 2fps 1fps	Frame rate for slow/quick motion shooting (71)
	Writing data / Number of images left to write

2

Display	Indication
	Drive Mode (45, 64)
	Flash Mode (68) / Red Eye Reduction (68)
1/2+0.0	Flash Comp. (68)

Display	Indication
	Location information (76)
90°44'55" N 233°44'55" W	Latitude/longitude information (76)
	Digital level gauge
CH1  CH2 	Audio Level Display (72)
D-R OFF DRO HDR HDR 	DRO / Auto HDR/ Auto HDR image warning (68)
	Picture Effect error
2016 - 1 - 1 10:37AM	Date of recording (34)
3/7	File number/Number of images in the view mode
 REC  STBY	REC Control (79)
	Spot metering area (67)
	Smart Telecon. (18)
00:00:00:00	Time code (hours: minutes: seconds: frames) (79)
00 00 00 00	User Bit (79)

Indicators on the display panel

You can set the shutter speed and aperture, exposure compensation, flash compensation, ISO, white balance, drive mode, etc., using the display panel on top of the camera.



Shutter speed/ Aperture		Exposure compensation (67) / Flash compensation (68)	
ISO sensitivity (67)		White Balance (68)	
Drive Mode (64) / Remote controller (79)		Image quality (49)	
Remaining battery (28)		Remaining number of recordable images (90)*	

* Even if the number of recordable images is higher than 9,999 images, "9999" will appear on the display panel.

To turn on the display panel backlight

Press the (Display panel illumination) button on top of the camera. If you press the button again, the display panel backlight will turn off.

(Display panel illumination) button



Specifications

Battery life and number of recordable images

		Battery life	Number of images
Shooting (still images)	Screen mode	—	Approx. 490
	Viewfinder mode	—	Approx. 390
Actual shooting (movies)	Screen mode	Approx. 85 min.	—
	Viewfinder mode	Approx. 85 min.	—
Continuous shooting (movies)	Screen mode	Approx. 135 min.	—
	Viewfinder mode	Approx. 135 min.	—

- The above estimates for battery life and number of recordable images apply when the battery pack has been fully charged. The battery life and number of images may decrease depending on the conditions of use.
- The battery life and number of recordable images are estimates based on shooting under the following conditions:
 - Using the battery pack at an ambient temperature of 25°C (77°F).
 - Using a 28-75mm F2.8 SAM lens (sold separately)
 - Using a Sony SDXC memory card of UHS Speed Class 3 (**U3**) (sold separately)
 - [Viewfinder Bright.]: [Manual] [±0]
 - [Monitor Brightness]: [Manual] [±0]
 - [Display Quality]: [High]
- The numbers for “Shooting (still images)” are based on the CIPA standard and shooting under the following conditions:
(CIPA: Camera & Imaging Products Association)
 - DISP: [Display All Info.]
 - [Focus Mode]: [Automatic AF]
 - One picture is taken every 30 seconds.
 - The power is turned on and off once every ten times.

- The number of minutes for movie shooting is based on the CIPA standard and shooting under the following conditions:
 - The image quality is set to XAVC S HD 60p 50M / 50p 50M.
 - Actual shooting (movies): Battery life based on repeatedly shooting, zooming, shooting stand-by, turning on/off, etc.
 - Continuous shooting (movies): Battery life based on non-stop shooting until the limit (29 minutes) has been reached, and then continued by pressing the MOVIE (Movie) button again. Other functions, such as zooming, are not operated.

Memory cards that can be used

You can use the following types of memory cards with this camera. The ✓ mark indicates that these memory cards can be used for shooting still images or movies.

When using Memory Stick Micro media or microSD memory cards with this camera, make sure to use with the appropriate adaptor.

Memory card	For still images	For movies		
		MP4	AVCHD	XAVC S
Memory Stick PRO Duo	✓	✓ (Mark2 only)	✓ (Mark2 only)	—
MemoryStick PRO-HGDuo™	✓	✓	✓	✓*1
Memory Stick Micro™ (M2)	✓	✓ (Mark2 only)	✓ (Mark2 only)	—
SD memory card	✓	✓*2	✓*2	—
SDHC memory card	✓	✓*2	✓*2	✓*3
SDXC memory card	✓	✓*2	✓*2	✓*3
microSD memory card	✓	✓*2	✓*2	—
microSDHC memory card	✓	✓*2	✓*2	✓*3
microSDXC memory card	✓	✓*2	✓*2	✓*3

*1 Movies cannot be recorded in 100 Mbps or more.

*2 SD Speed Class 4 (CLASS 4) or faster, or UHS Speed Class 1 (U1) or faster

*3 SD Speed Class 10 (CLASS 10), or UHS Speed Class 1 (U1) or faster

When recording in 100 Mbps or more, UHS Speed Class 3 (U3) is required.

Note

- Memory Stick media cannot be used in the slot 2.
- When an SDHC memory card is used to record an XAVC S movie over extended periods of time, the recorded movies will be divided into files 4 GB in size. The divided files can be handled as a single file by importing them to a computer using PlayMemories Home.
- When recording a movie on memory cards in both the slot 1 and the slot 2 with following camera settings, insert two memory cards with the same file system. XAVC S movies cannot be recorded simultaneously when using a combination of the exFAT file system and FAT32 file system.
 - [File Format] is set to [XAVC S 4K] or [XAVC S HD]
 - [Recording Mode] is set to [Simult. (📷)] or [Simult. (📷/📷)]

Memory card	File system
SDXC memory card	exFAT
Memory Stick PRO Duo (Mark2) Memory Stick PRO-HG Duo SDHC memory card	FAT32

Number of recordable images

When you insert a memory card into the camera and set the power switch to "ON," the number of images that can be recorded (should you continue to shoot using the current settings) is displayed on the screen.

Note

- When "0" (the number of recordable images) flashes in orange, the memory card is full. Replace the memory card with another one, or delete images from the current memory card.
- When "NO CARD" flashes in orange, it means no memory card has been inserted. Insert a memory card.

■ The number of images that can be recorded on a memory card

The table below shows the approximate number of images that can be recorded on a memory card formatted with this camera. The values are defined using Sony standard memory cards for testing. The values may vary depending on the shooting conditions and the type of memory card used.

[Image Size]: [L: 42M]

[Aspect Ratio]: [3:2]*

(Units: Images)

Quality	8 GB	16 GB	32 GB	64 GB
Standard	770	1550	3100	6200
Fine	520	1000	2100	4200
Extra fine	270	540	1050	2150
RAW & JPEG (Compressed RAW)	130	260	520	1050
RAW (Compressed RAW)	170	350	700	1400
RAW & JPEG (Uncompressed RAW)	75	150	300	600
RAW (Uncompressed RAW)	88	175	355	710

* When [Aspect Ratio] is set to other than [3:2], you can record more images than the numbers shown in the table above (except when [RAW] is selected).

Note

- Even if the number of recordable images is higher than 9999 images, “9999” will appear.
- When an image shot with another product is played back on this camera, the image may not appear in its actual size.
- The numbers shown are when using a Sony memory card.

Recordable movie times

The table below shows the approximate total recording times using a memory card formatted with this camera. The values may vary depending on the shooting conditions and the type of memory card used. The recording times for when [File Format] is set to [XAVC S 4K], [XAVC S HD], and [AVCHD] are recording times when shooting with [Dual Video REC] set to [Off].

(h (hour), m (minute))

File Format	Record Setting	8 GB	16 GB	32 GB	64 GB
XAVC S 4K	30p 100M/ 25p 100M	9 m	15 m	35 m	1 h 15 m
	30p 60M/ 25p 60M	15 m	30 m	1 h	2 h 5 m
	24p 100M*	9 m	15 m	35 m	1 h 15 m
	24p 60M*	15 m	30 m	1 h	2 h 5 m
XAVC S HD	120p 100M/ 100p 100M	9 m	15 m	35 m	1 h 15 m
	120p 60M/ 100p 60M	15 m	30 m	1 h	2 h 5 m
	60p 50M/ 50p 50M	15 m	35 m	1 h 15 m	2 h 35 m
	30p 50M/ 25p 50M	15 m	35 m	1 h 15 m	2 h 35 m
	24p 50M*	15 m	35 m	1 h 15 m	2 h 35 m
AVCHD	60i 24M (FX)/ 50i 24M (FX)	40 m	1 h 25 m	3 h	6 h
	60i 17M (FH)/ 50i 17M (FH)	55 m	2 h	4 h 5 m	8 h 15 m
	60p 28M (PS)/ 50p 28M (PS)	35 m	1 h 15 m	2 h 30 m	5 h 5 m
	24p 24M (FX)/ 25p 24M (FX)	40 m	1 h 25 m	3 h	6 h
	24p 17M (FH)/ 25p 17M (FH)	55 m	2 h	4 h 5 m	8 h 15 m

File Format	Record Setting	8 GB	16 GB	32 GB	64 GB
MP4	1920×1080 60p 28M/50p 28M	35 m	1 h 15 m	2 h 35 m	5 h 20 m
	1920×1080 30p 16M/25p 16M	1 h	2 h	4 h 10 m	8 h 25 m
	1280×720 30p 6M/25p 6M	2 h 35 m	5 h 20 m	10 h 55 m	22 h

- * Only when [NTSC/PAL Selector] is set to NTSC
- Continuous shooting is possible for approximately 29 minutes (a product specification limit). The continuous recordable time may differ in the following situations:
 - When the file format is set to MP4 (28M): Approximately 20 minutes (limited by file size of 4 GB).
 - When shooting slow-motion/quick-motion movies: Recording will automatically stop when the recorded file reaches approximately 29 minutes (the played back movie reaches approximately 29 minutes).
(Recording will automatically stop when the recorded file reaches approximately 15 minutes if [S&Q Record Setting] is set to [60p/50p] and [S&Q Frame Rate] is set to [30fps/25fps].)
 - The times for slow-motion/quick-motion movies are playback times, not recording times.

Note

- The recordable time of movies varies because the camera is equipped with VBR (Variable Bit-Rate), which automatically adjusts image quality depending on the shooting scene. When you record a fast-moving subject, the image is clearer but the recordable time is shorter because more memory is required for recording. The recordable time also varies depending on the shooting conditions, the subject or the image quality/size settings.
- The times shown are recordable times using a Sony memory card.

Notes on continuous movie recording

- It requires a lot of power to perform high quality movie recording or continuous shooting using the image sensor. Therefore, if you continue to shoot, the temperature inside the camera will rise, especially that of the image sensor. In such cases, the camera turns off automatically since higher temperatures affect the quality of the images or affect the internal mechanism of the camera.
- The following values are the continuous times from when the camera starts recording until the camera stops recording.

Ambient temperature	Continuous recording time for movies (HD)	Continuous recording time for movies (4K)
20°C (68°F)	Approx. 29 min.	Approx. 29 min.
30°C (86°F)	Approx. 29 min.	Approx. 29 min.
40°C (104°F)	Approx. 29 min.	Approx. 29 min.

HD: XAVC S HD (60p 50M/50p 50M)

4K: XAVC S 4K (Super 35 mm, 60 Mbps)

- The duration of time available for movie recording varies with the temperature or condition of the camera before you start recording. If you frequently recompose or shoot images after the power is turned on, the temperature inside the camera will rise and the recording time available will be shorter.
- When [] is indicated, stop recording the movie.
- If the camera stops recording due to the temperature, leave it for some time with the power turned off. Start recording after the temperature inside the camera drops fully.
- If you observe the following points, the recording time will be longer.
 - Keep the camera out of direct sunlight.
 - Turn the camera off when it is not being used.
- When [] File Format is set to [AVCHD], the file size of movies is limited to approx. 2 GB. If the movie file size reaches approx. 2 GB during recording, a new movie file will be created automatically.
- When [] File Format is set to [MP4], the file size of movies is limited to approx. 4 GB. If the movie file size reaches approx. 4 GB during recording, recording will stop automatically.

Specifications

Camera

[System]

Camera Type

Interchangeable Lens Digital Camera

Lens

Sony A-mount lens*

* When using a DT lens, shooting automatically switches to the APS-C size.

[Image sensor]

Image format

35 mm full frame (35.9 mm × 24.0 mm), CMOS image sensor

Effective pixel number of camera

Approx. 42 400 000 pixels

Total pixel number of camera

Approx. 43 600 000 pixels

[SteadyShot]

System

In-camera sensor shift image stabilization system

[Anti-Dust]

System

Charge protection coating on optical filter and image sensor shift mechanism

[Auto focus system]

Detection system

TTL phase-detection system

Detection sensors

Detection sensor 1:

CCD linear image sensor

Detection sensor 2:

Focal plane phase detection sensor

Number of focus points

Detection sensor 1:

79 points (15 cross-type points, F2.8-sensitive at the center point)

Detection sensor 2:

399 points (323 selectable points, 79 Hybrid Cross AF Points*)

* When Hybrid Phase Detection AF is activated

Sensitivity Range

Detection sensor 1: -4 EV to +18 EV (center area, at ISO 100 equivalent, F2.8)

[Electronic viewfinder]

Type

Electronic viewfinder

Total number of dots

2 359 296 dots

Frame coverage

100%

Magnification

Approx. 0.78× with 50 mm lens at infinity, -1 m⁻¹

Eye Point (CIPA standard compliant)

Approx. 23 mm from the eyepiece, approx. 18.5 mm from the eyepiece frame at -1 m⁻¹

Diopter Adjustment

-4.0 m⁻¹ to +3.0 m⁻¹

[Monitor]

LCD monitor

7.5 cm (3.0 type) TFT drive

Total number of dots

1 228 800 (640 × 4 (RGBW) × 480) dots

[Exposure control]

Metering method

1 200-zone evaluative metering

Metering range

-2 EV to +17 EV (at ISO 100 equivalent with F1.4 lens)

ISO sensitivity (Recommended exposure index)

Still images: ISO 100 to 25 600 (Extended ISO: Minimum ISO 50, maximum ISO 102 400), [ISO AUTO] (ISO 100 to 6 400, Maximum/Minimum can be set.)

Movies: ISO 100 to 25 600 equivalent, [ISO AUTO] (ISO 100 to 6 400 equivalent, Maximum/Minimum can be set.)

Exposure compensation

±5.0 EV (switchable between 1/3 EV and 1/2 EV steps)

[Shutter]

Type

Electronically-controlled, vertical-traverse, focal-plane type

Speed range

Still images: 1/8 000 second to 30 seconds, BULB

Movies: 1/8 000 second to 1/4 second (1/3 EV step)



- 1080 60i-compatible devices:
up to 1/60 second in AUTO mode (up to 1/30 second in Auto slow shutter mode)
- 1080 50i-compatible devices:
up to 1/50 second in AUTO mode (up to 1/25 second in Auto slow shutter mode)

Flash sync speed

1/250 second (when using a flash manufactured by Sony)



[Continuous shooting]

Continuous shooting speed

: Maximum of 12 images per second/
 Hi: Maximum of 8 images per second

- Based on our measurement conditions. The speed of continuous shooting can be slower, depending on the shooting conditions.

Number of continuous shots

: Extra fine 60 images
 Hi: Extra fine 65 images

[Recording format]

File format

JPEG (DCF Ver. 2.0, Exif Ver. 2.31, MPF Baseline) compliant, RAW (Sony ARW 2.3 format)

Movie (XAVC S format)

MPEG-4 AVC/H.264 XAVC S ver.1.0 format compliant

Video: MPEG-4 AVC/H.264

Audio: LPCM 2ch (48 kHz 16 bit)

Movie (AVCHD format)

AVCHD format Ver. 2.0 compatible

Video: MPEG-4 AVC/H.264

Audio: Dolby Digital 2ch, equipped with Dolby Digital Stereo Creator

- Manufactured under license from Dolby Laboratories.

Movie (MP4 format)

Video: MPEG-4 AVC/H.264

Audio: MPEG-4 AAC-LC 2ch

[Recording media]

Memory Stick media, SD cards

- For details, see "Memory cards that can be used" (page 89).

[Slot]

SLOT1

Multi-slot for Memory Stick PRO Duo media and SD cards (UHS-I compatible)

SLOT2

Slot for SD cards (UHS-I compatible)
Supports operations between two memory cards.

[Input/output terminals]

Multi/Micro USB Terminal*

Hi-Speed USB (USB 2.0)

* Supports Micro USB compatible devices.

HDMI

HDMI type D micro jack

🎤 (Microphone) Terminal

∅ 3.5 mm Stereo mini jack

🎧 (Headphones) Terminal

∅ 3.5 mm Stereo mini jack

REMOTE

[Power, general]

Battery pack

Rechargeable battery pack
NP-FM500H

Power consumption (while shooting)

Using a 28-75mm F2.8 SAM

When using the viewfinder:

Approx. 3.6 W

When using the monitor:

Approx. 2.9 W

[Others]

Microphone

Stereo

Speaker

Monaural

Exif Print

Compatible

DPOF

Compatible

PRINT Image Matching III

Compatible

Dimensions

Approx. 142.6 mm × 104.2 mm × 76.1 mm

(Approx. 5 5/8 inches × 4 1/8 inches × 3 inches) (W/H/D, excluding protrusions)

Mass

Approx. 849 g (1 lb 13.9 oz)

(including battery pack and Memory Stick PRO Duo media)

Approx. 770 g (1 lb 11.2 oz) (body only)

Operating temperature

0°C to 40°C (32°F to 104°F)

Storage temperature

-20°C to +60°C (-4°F to +140°F)

[Wireless LAN]

Supported format

IEEE 802.11 b/g/n

Frequency band

2.4 GHz bandwidth

Security

WEP/WPA-PSK/WPA2-PSK

Connection method

Wi-Fi Protected Setup™ (WPS)/
Manual

Access method

Infrastructure mode

[NFC]

Tag type

NFC Forum Type 3 Tag compliant

[Bluetooth communications]

Bluetooth® standard Ver. 4.1

Frequency band

2.4 GHz bandwidth

Model No. WW067022

Battery charger BC-VM10A

Input rating

AC 100 V to 240 V, 50 Hz/60 Hz, 9 W

Output rating

DC 8.4 V, 750 mA

Rechargeable battery pack

NP-FM500H

Nominal voltage

DC 7.2 V

Design and specifications are subject to change without notice.

On image data compatibility

- This camera conforms with DCF (Design rule for Camera File system) universal standard established by JEITA (Japan Electronics and Information Technology Industries Association).
- Playback of images recorded with your camera on other equipment and playback of images recorded or edited with other equipment on your camera are not guaranteed.

Trademarks



- Memory Stick and  are trademarks or registered trademarks of Sony Corporation.
- XAVC S and  are registered trademarks of Sony Corporation.
- “AVCHD Progressive” and the “AVCHD Progressive” logotype are trademarks of Panasonic Corporation and Sony Corporation.
- Mac is a registered trademark of Apple Inc. in the United States and other countries.
- IOS is a registered trademark or trademark of Cisco Systems, Inc.
- iPhone and iPad are registered trademarks of Apple Inc. in the United States and other countries.
- Blu-ray Disc™ and Blu-ray™ are trademarks of the Blu-ray Disc Association.
- DLNA and DLNA CERTIFIED are trademarks of Digital Living Network Alliance.
- Dolby and the double-D symbol are trademarks of Dolby Laboratories.
- Eye-Fi is a trademark of Eye-Fi, Inc.
- The terms HDMI and HDMI High-Definition Multimedia Interface, and the HDMI Logo are trademarks or registered trademarks of HDMI Licensing LLC in the United States and other countries.
- Microsoft and Windows are registered trademarks or trademarks of Microsoft Corporation in the United States and/or other countries.
- SDXC logo is a trademark of SD-3C, LLC.

- Facebook and the “f” logo are trademarks or registered trademarks of Facebook, Inc.
- Android and Google Play are trademarks or registered trademarks of Google Inc.
- YouTube and the YouTube logo are trademarks or registered trademarks of Google Inc.
- Wi-Fi, the Wi-Fi logo and Wi-Fi Protected Setup are registered trademarks or trademarks of the Wi-Fi Alliance.
- The N Mark is a trademark or registered trademark of NFC Forum, Inc. in the United States and in other countries.
- The Bluetooth® word mark and logos are registered trademarks owned by the Bluetooth SIG, Inc. and any use of such marks by Sony Corporation is under license.
- In addition, system and product names used in this manual are, in general, trademarks or registered trademarks of their respective developers or manufacturers. However, the ™ or ® marks may not be used in all cases in this manual.



■ On GNU GPL/LGPL applied software

The software that is eligible for the following GNU General Public License (hereinafter referred to as “GPL”) or GNU Lesser General Public License (hereinafter referred to as “LGPL”) are included in the product.

This informs you that you have a right to have access to, modify, and redistribute source code for these software programs under the conditions of the supplied GPL/LGPL. Source code is provided on the web. Use the following URL to download it. <http://oss.sony.net/Products/Linux/> We would prefer you do not contact us about the contents of source code.

Licenses (in English) are recorded in the internal memory of your product. Establish a Mass Storage connection between the product and a computer to read licenses in the “PMHOME” - “LICENSE” folder.

Additional information on this product and answers to frequently asked questions can be found at our Customer Support Website.

<http://www.sony.net/>

0-9

4K movie50

A

AF39

AF-A.....37

AF-C.....38

AF-S.....37

Auto focus.....39

Auto Mode35

AVCHD.....50, 51

AWB.....68

B

Battery pack29

C

Charging.....28

Clear Image Zoom73

Clock setting34

Computer58, 60

Cross-type AF area.....39, 40

Custom white balance.....68

D

Date imprint.....35

Date/Time Setup34

Dedicated phase detection AF area
.....39, 40

Delete.....36

Digital Zoom73

Diopter-adjustment.....17

Direct manual focus.....38, 44

DISP73

DMF38, 44

DRO68

E

Eye-Fi.....78

F

Fn18, 25

Focal plane phase detection AF area
.....39

Focus.....37

Focus indicator.....38

Front multi-controller23

Function button25

H

HDR68

Help Guide2

Hybrid Cross AF points39

Hybrid Phase Detection AF system
.....39, 42

I

Image Data Converter60

In-Camera Guide.....2

Intelligent Auto35

L

Language11

Lens.....32

List of icons82

M

Memory card.....30, 89

MENU.....62

MENU button18, 62

MENU items	63
MF.....	38, 43
Monitor.....	82
Movie.....	36, 50
MOVIE button	18
Movie file format	51
MP4	51
Multi-selector.....	23

N

NFC.....	10, 56
Noise Reduction.....	63

O

One-touch(NFC).....	56
---------------------	----

P

Playback.....	36
PlayMemories Home	60
Printing.....	77

Q

Quick Navi	26
------------------	----

R

RAW.....	49
Recordable number of images.....	90
Recordable time of movies	92
Remote Camera Control.....	61

S

Select Rec. Media	30
Sensitivity.....	67
Smart Zoom	73
Software.....	60
Specifications.....	95
Still image	35

V

Volume.....	78
-------------	----

W

WB.....	68
Wi-Fi	10, 56

X

XAVC S.....	50
XAVC S 4K.....	51
XAVC S HD.....	51



<http://www.sony.net/SonyInfo/Support/>



4688165120